



 **Sheldon**
LABORATORY SYSTEMS
since 1898

Art Systems Catalog

Thank you for taking time to review Sheldon Laboratory System's art system catalog. This catalog will give you some insight into the capabilities, resources and services offered by Sheldon. As the industry's premier supplier of science, art, life science, biology, chemistry, and physics casework as well as specialty products, our mission is simple:

Provide the most reliable AND innovative products on time and complete... every time.

Our team is passionate about providing only the best quality and most innovative products as well as the best service in the industry. At the same time, we strive to be the easiest company with which to do business.

Our company has a rich tradition of listening to educators, architects and end-users to ensure we provide environments that make the important job of teaching sciences easier. Our 100-plus-year history includes the creation of many unique and innovative products, and we are committed now, more than ever, to new product development.

We understand that building a school laboratory is not just a matter of placing an order... but a science in itself! Our highly experienced team can be a tremendous aid to you throughout the entire lab-planning process.

We look forward to being your casework supplier of choice and thank you for reviewing this catalog. We encourage you to contact one of our sales managers to learn more about the many products and services we provide.

FACILITY PLANNING

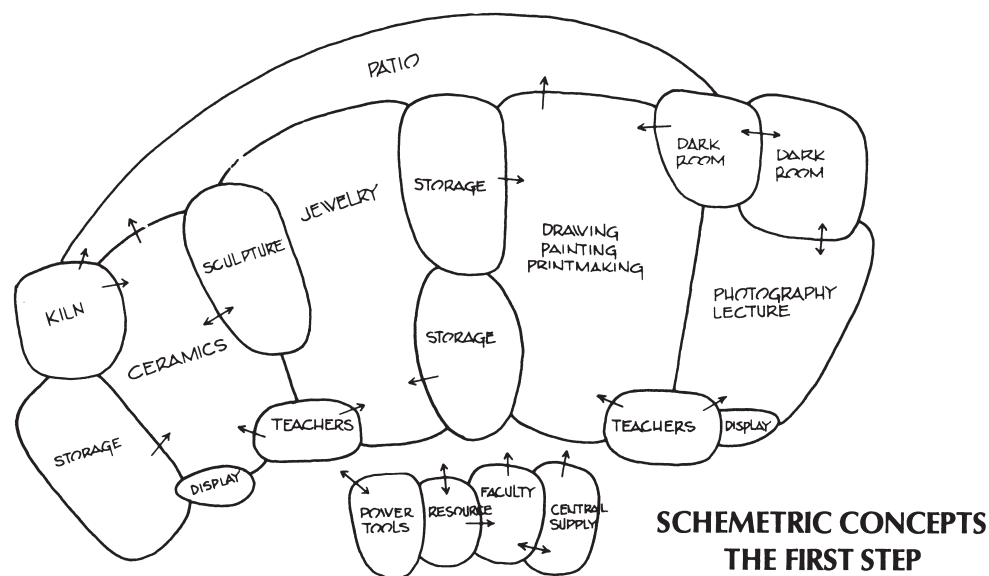

**SCHEMATIC CONCEPTS
THE FIRST STEP**

Art Education Today and Tomorrow

From a few applied art courses, teaching floral painting and some portrait work, art education has moved far in the past 100 years. From being taught by one teacher with little training in one room with little equipment, art education has grown across the nation to an estimated 50,000 teachers at all levels of education. It has grown in both numbers and scope of program. This broadening from drawing and painting now includes print making, ceramics, jewelry, all forms of crafts such as films, photography, fashion design, industrial design, computing graphics, animation, and on and on.

Junior and senior high schools that in the 1930s, 40s, and 50s had one all-purpose art room, now include a suite of art studio rooms. Each is designed for specialized art courses.

Elementary schools in which art was taught on Friday afternoons by the classroom teacher in hundreds and thousands of schools, now have full time elementary art teachers who are teaching in specially designed art studios. Facilities at these grade levels are comparable to the art studios for junior and senior high schools.

Career opportunities in the arts have multiplied as fast as the number of teachers and programs. The National Art Education Association (NAEA) focused much of its energy during recent years on the area of career opportunities for young people, and to alerting teachers, administrators, parents and students of over 900 opportunities available in the areas of art and art related fields.

The plans and means for implementing art programs presented in this book reflect that growth and interest on the part of students as well as the support of school boards, administrators and parents in the implementation.

Current Status and Enrollment

Approximately 50 percent of the students at the junior high level in our nation are enrolled, or will enroll, in art during their junior high or middle school education. In many middle schools, art is required for at least one semester, and often for one year. Whether required or elective, enrollment in art courses seems to be consistent, with approximately 50 percent participating. Ten years ago, surveys made by NAEA indicated that something less than 10 percent of the senior high students in the nation were enrolled in Art. A current survey conducted by Sheldon Laboratory Systems with cooperation of NAEA, indicates that between 23 percent and 27 percent of all high school students are currently enrolled in Art. The facilities described herein reflect enrollment trends, and the best possible projections indicate that these figures will maintain themselves, even though there is not an increase in the school enrollment.

The facilities illustrated and described in these pages should meet the needs of the students for years to come, and could be easily converted should modifications be necessary in program or facility. All have set areas and adequate storage to house expanded or new programs, since careful consideration has been given to future flexibility.

FACILITIES PLANNING

Who Enrolls in Art and Why

The largest use of the art facilities is, obviously, the student population. Adult education provides the next, and this is a growing group. Active and retired adults, summer programs for gifted and talented and career oriented enrichment programs for students also create greater usage of the facilities. Our schools throughout the nation are being used as year around learning centers by day and evening, and better facilities are needed. The closer school art studios are to areas in which adults and students live, the more use will be made of them.

Current and future energy problems face the nation. If school facilities fill the local needs adequately, we will save many dollars not only in energy, but in the use over and above the dollars invested. People are entering Art in all areas of art education because they want to learn about art. There is an oncoming attitude about art in the nation. It's something people feel they should know. Most educators now call art basic to well rounded knowledge. People also want to know about art history and our culture -- future and past. They want to learn something special: how to make a pot, how to do photography, how to make jewelry, how to paint, how to work with materials, build a sculpture, etc. Research indicates that visual learning is a most important part of any child's or adult's education.

What It Takes To Provide For Art Education

The space in which teaching takes place must be large. Classes, although too large, may run to 32, with sometimes 6 to 7 or even 8 classes per day. These rooms must have secured in-room storage, adequate large sinks, and good lighting, including the ability to show slides during the day and evening as well. While using films, the sound levels must be controlled. Controlled ventilation must remove fumes, making the rooms safe and accessible to special children and adults. People confined to wheel chairs must have easy access to the facilities. A resource center is needed within the art studios. Art rooms at all three levels -- elementary, junior and senior high school -- need north light and access to adjacent patios. If there are three or four art studios in a school, they must be clustered so that teachers can team teach. A teacher's planning area encourages teachers to work together. The resource center need not be as large as the school's central media, or library center, but does need to be large enough to house books, slides and prints in large numbers so that both students and adult groups working in the facilities are able to easily select materials they need for specific problems they are handling in Art.

Carefully prepared Facts and Figures to help facility planners are in this book. They are based on the recent survey Sheldon conducted to help them make the contents of this book "Educationally Correct". By using this information at the earliest start of planning art facilities, art educators will be helping themselves to obtain teacher-student efficiencies for the benefits of all for many years ahead. The suggested art studio plans included in this book can be altered to your educational specifications and student work loads. Room sizes do vary, but square footage must be comparable if the art education activities are to be administered effectively. Sheldon Laboratory Systems has an excellent planning department. Study the Facts and Figures Data in this book and prepare your own data of your educational requirements. Send this information along with preliminary drawings of your art department. Without obligation your facility planning information will be interpreted into procurement drawings of your actual rooms. Budget type cost estimates and detailed equipment specifications will, at your request, be provided.

FACTS & FIGURES

Essential Data for Planning Art Studios for Elementary Schools — Middle Schools Senior High Schools — Community Colleges

Art Rooms

The Art Facility is a workroom and a laboratory. It is by nature a messy, dirty, noisy area and should be designed to fit its function. The physical space should be self-contained and securable, requiring cleanable type floors and maintainable walls for display and fixtures.

The class size is generally 24 - 32. Art activities covered in the art room are drawing, painting, printmaking, ceramics, sculpture, batik, photography, jewelry, wood and paper constructions, weaving, stitchery, art appreciation and display.

Art Studios must be based on school enrollment.

	No. of Students			
No. of Studios	Up to 500	1000	1500	2000 up
	1	2	3 to 4	5 or more

This "rule of thumb" applies to all schools.

FACTS & FIGURES

The facilities and equipment needs are the same for a small school with one “all-purpose” room as they are for the large school having 5 or more studios. Only the quantities of space and equipment vary. The educational opportunities remain the same.

Example: The small school may have only one class in pottery making; whereas, the large school may have 6 classes, using an entire room for ceramics.

Both schools will need for teaching ceramics:

A Kiln Room,
Potter’s Wheels,
Kilns,
Pug Mill,

Sinks with plaster traps,
Student Project Storage,
Wedging Table,
Glazing Facilities.

Both schools will require comparable lists of equipment for drawing, painting, printmaking, photography including dark-room, sculpture, jewelry, and textiles. See the *Educationally Correct*[®] room layouts for art studios for various size schools. These are in the pocket on the inside of the back cover of this book. An important consideration is to plan for growth, particularly in the all-purpose art room. As the room becomes fully scheduled for all art activities, student project storage must be planned at the start to allow for this growth.

Enrollment determines the number of specialized studios. In large schools it becomes easier to separate the areas (drawing, painting, ceramics, sculpture, jewelry, etc.), by their special equipment, ventilating, and cleaning demands.

Location of art studios should be on the north side of the building for indirect natural lighting. Ground floor level is needed for delivery of heavy supplies, equipment, and transporting finished art work. An outside exit is needed. This can be to a patio, and double doors are preferable.

A patio area adjacent to the art department should be provided for large sculpture and clay work, and for noisy work. Water faucet with antifreeze shut-off is required for general work and clean up. Weather approved electrical outlets are needed on the patio.

The art studio should have provisions for darkening the room for showing slides, films, and spotlighting still life props.

Proper artificial and natural lighting is essential for true color presentations for drawing, painting, printmaking, dyes, glaze samples, etc.

The ventilating system should handle fumes, odors, and dust peculiar to these particular areas. Health and safety standards should be determined and met. Odors range from turpentine, to lacquer thinners, to acids, to toxic markers, to gases from melted waxes, etc. Special areas such as the kiln room, jewelry bench, pug mill, burn-out kilns, and acid areas require additional specific ventilation.

Electric outlets should be supplied frequently throughout the art rooms to avoid the use of extension cords. The use of unsightly drop cord type outlets is minimized when Student Work Towers are strategically located in the room. These Towers can be furnished with strips of plug mold outlets on the top rails, connected to junction box in the floor. All electrical outlets need to be “ground fault protected” for safety.

Equipment manufacturer’s specific electric requirements for kilns and burn-out station should be known and properly provided. Separate circuits are required for potter’s wheels.

Floors in the art room should be of sealed concrete for durability and ease of cleaning. Floors should have a gradual slope to a long, trough-type floor drain, complete with a plaster clay trap which can easily be cleaned. The drain should be covered by a metal grate. Means should be provided to hose the floor down in all dirty areas and squeegeed into the drain.

Regardless of the enrollment, the following is a list of facilities, equipment, and space requirements applicable to all art education departments. The student load must be used to establish quantities.

STUDIO SPACE

This is the actual working area to be taken by students, tables, seating, student centers, project stations, and counters. This does not include materials storage room, teacher planning station, the darkroom, nor the kiln room. Allow 55 square feet per student. For 30 students, 1,650 square feet are needed.

Items required in the Studio Space:

1. Student 2-dimensional work-in-progress storage. Space is conserved by installing units designed for this intended purpose.
2. Student 3-dimensional work-in-progress storage. Items selected from within the book must accommodate pottery, sculpture, weaving, rug hooking, batiks, macrame, jewelry, etc.
3. Student work and clean-up sinks. Sinks should be far apart to permit good traffic flow at clean-up time. Several hot and cold water faucets are desirable at each sink. These sinks require plaster traps. One clean-up sink for every 12 students is minimum.
4. A sturdy grid system near the ceiling, or off Student Work Tower and EC support rails, provides for hanging mobiles, large macrames, weavings, still life drapery, props, batiks, sculptures, etc. Wires should be specified to be of proper strength

FACTS & FIGURES

for the intended hanging loads. The grids should cover the ceiling of the display areas in approximately three-foot-square grid units.

5. Display panels for displaying finished 2-dimensional work. Spot lighting from a track is desirable. The tackboard area should be a minimum of 32 square feet.

6. Track spotlighting is needed throughout the studio space for highlighting still life displays, models, and student value studies at the drawing tables.

7. The area for the pug mill needs to be 8'-0" x 3'-0" wide, and a hooded exhaust fan above is required for dust removal.

8. The sculpture and wedging station can be combined in a single item conserving space. Storage space is needed for chemical storage.

9. A clay slab roller will require 18 square feet of floor space (6' x 3').

10. Potter's wheels. Allow 15 square feet of floor space, including working space, for each potter's wheel. Determine that adequate electric circuits are available. Electric cords should be off the floor where clay and water are spilled.

11. Glazing spray booth requires proper lighting, exhaust fan, ventilation hood, and a turntable. Air compressor or piped in air is required. Also, electric service to operate a spray gun should be available as a part of the booth, or adjacent to it.

12. A large buffer/grinder on a stand, or bench, with good lighting requires about 4 square feet plus 4 square feet for the operator.

13. Glazing buckets and clay carts need a home base and need to be of 10 to 12 gallon capacity. They need to have heavy duty bases having hard rubber casters.

14. The soldering bench for jewelry requires individual soldering stations with a fire resistant divider. Each station needs approximately 30" x 24" working space. The working surface should be of hard fire brick laid in metal frame or high density asbestos board 1-1/4" thick. Individual pressure regulator valves for gas and oxygen are required at each work station.

15. Bottles and dishes for acids used to clean metals before soldering should be housed in a locked screen cage.

16. The gas supply in the room should be piped to the locations indicated on floor plans. Small individual tanks are not satisfactory.

17. Special ventilation is required above the soldering, welding, casting and burn-out areas for fume and soot removal.

18. Centrifugal casting must have the unit safely anchored. It should be in a corner. Allow 9 square feet for this unit. Make certain that the centrifugal caster that you purchase will fit in the well.

19. The electric burn-out kilns, adjacent to the ventilating hood, require an area of 36" x 30", or 7-1/2 square feet. The base and wall should be of fireproof material.

20. Provide a glass display case for displaying finished work.

21. Student work tables must be very sturdy with quality heavy working surfaces capable to serve many uses.

22. Electric pottery kilns, jewelry burn-out kilns, enameling kilns should be selected before the building is started in order that proper capacity electric services can be brought to the proper places within the studios.

23. Printing press for printmaking requires 3' x 5' floor space.

24. Drying rack for wet 2-D projects require mesh shelves for air circulation.

25. Wood and plastic sculpture and jewelry require a band saw, and needs 9 square feet of space.

26. Provide eight potter's wheels for school with up to 1000 students, ten for 1500 students, and twelve for 2000 students.

27. A belt sander for sculpture and jewelry requires 6 square feet.

28. A flexible shaft grinder for sculpture requires 9 square feet.

29. A welding booth with oxygen/acetylene tanks on a portable cart uses 16 square feet for the booth and 6 square feet for tanks.

SECURITY

"Lock everything. Student work must be protected from damage by others; materials must be protected against thievery, etc." This is often a quick and expensive judgement. Evaluation is needed.

The insistence of total security diverts a high percent of the equipment dollar from more and better facilities. The problem warrants careful decision making at the time educational specifications are established. Many factors affect the degree of security justified. We suggest that each art education planner obtain from your Sheldon Representative budget estimates for security costs.

The cost must include more than the price of the lock itself. For example, between vertically stacked drawers a full panel must be installed, else by removing a locked top drawer, access is permitted to the locked drawer below and all security costs on that item are for naught. Tall doors to be secure require pull chains, or fixed catches, top and bottom, plus the lock. All locks require boring and installation. If students are to have access, all keys within a studio must be tagged and stored in key cabinets, as well as the instructor having a master key.

Cabinet locks often become a challenge to students' ingenuity. Students, intent on access, will succeed. Often the key opening is nervously stuffed and made inoperable, or, the key is broken off within the lock, or the key is lost. The investment in total security is then lost. Locks to the room itself, or to storage areas with the room, are practicable and desirable.

Our best advice is to consider the type of security required early in your educational specification and facility planning and keep the real cost of security in relation to the value.

FACTS & FIGURES

STORAGE

The storage space required for an Art Studio must be better developed and specialized than other disciplines within an educational facility. Extra large and deep storage for paper sheets and poster boards; extra security for jewelry parts; small drawers for brushes, paints, beads; ventilated storage and shelves for ceramics and photography; student work-in-progress for pottery, drawings, sculpture, weaving, etc. Careful consideration must be given or storage for some area's materials and work-in-progress may be overlooked.

Generally allow 200 square feet of floor space per 30 student Studios or 6.6 square feet per student. This storage should be divided between storage room and in-studio storage as educational requirements dictate. Refer to preceding subject areas for specific types and spaces necessary.

If items are to be stored in storage room, planning must include mobile transports to move the materials and work-in-progress from the storage room to the studio and back. Mobile transports must be allotted storage space in both the store room and the Studio.

TEACHER PLANNING STATION

Each teacher should have 100 square feet of space. The following equipment is required: Counter top desk for each teacher; file cabinet, for filing purchase requisitions, records, memos, etc.; book shelves for art books and magazines, slide trays, and other resource material; lockable storage cabinet with adjustable shelves for finished student work to be graded, prints, posters, and personal property; telephone for emergency calls because of potentially dangerous equipment; and work table for matting and grading the art work.

KILN ROOM

This room requires 400 square feet.

A gas kiln 5-1/2' x 7' requires 38 square feet plus a three-foot wide working border around the kiln; total space, 150 square feet.

Electric kiln needs 45 square feet plus an 18" border around the kiln for radiant heat plus an additional 18" in front for loading and operation of the control switches. Total area needed is 45 square feet. Provide special wiring circuit to meet kiln manufacturer's requirements.

Gas supply and electric capacities to be determined when the space is planned. State and local codes must be met. Exhaust fan for heat build-up is required as well as air vents in the double doors or walls for fresh combustible air.

Provide adjustable metal shelves for glazeware pottery.

Metal storage cabinet for storing the kiln shelves, shelf supports, stilts, kiln wash, raku tongs, asbestos gloves, kiln door brick, etc. Raku kiln storage requires 9 square feet.

PHOTOGRAPHY

Both middle and secondary schools require photography. Only the secondary schools need color photography. Often photography can be combined with journalism and science programs; therefore, the location for a photography lab is very important. This area requires a minimum of 340 square feet - 100 square feet for film developing chemical mixing, 180 square feet for dark room printing and 60 square feet for finishing. Larger schools need additional 80 square feet for auxiliary dark room for color and sheet film work.

The enlarging area can only be used for photography processing. An adjoining area is needed for instruction, drymounting, negative spotting, print spotting, etc. Print drying racks require mesh shelves for air circulation.

Developing sinks to be type 316 stainless steel or molded structural polyester with all corners coved. Print washer to fit within sink. Print washer is best if circular to permit good print movement during washing. It should be at least 18 - 26 inches in diameter and 8 - 10 inches deep.

All drain piping in the Dark Room must be acid resisting. Light table top should be adjustable to different angles to a flat surface.

Darkroom needs a double light-safe door.

SAFETY

The importance of providing a safe environment cannot be overemphasized. Facility planners should, from the concept of a new building, consult with local, state, and federal agencies to become knowledgeable of all applicable safety requirements. The Art Studio has many activities taking place at the same time, and the need for safety precautions are special to each area. Activities can involve operating machinery; the handling of toxic and extremely high temperature materials; removing obnoxious and toxic fumes. Proper precautions must be established for each condition.

Educators employed by public Boards of Education must recognize their responsibility to the community. Safe working conditions are needed for all students, including adult and handicapped. The best protections against accidents and personal liability claims must be incorporated in the plans. Start by establishing proper space for each intended Art activity, then insist on adequate mechanical services for proper lighting, ventilating, floor drainage, etc. Finally, provide proper personal protection like eye glasses, safety covers, aprons, etc.

The art curriculum must include instruction on safety for all students as they start to work in each area.

INSTRUCTIONAL CENTERS

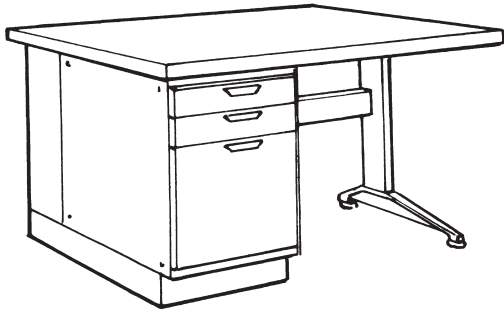
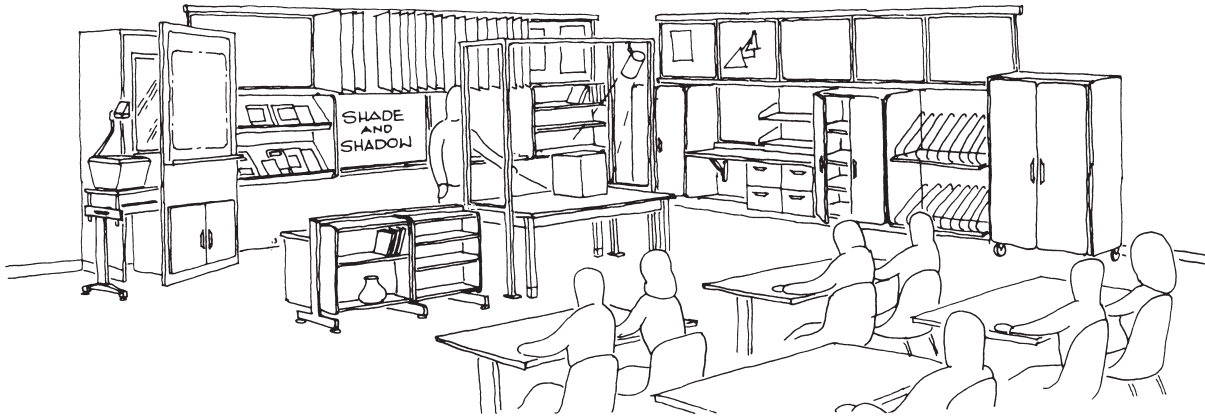

Teachers Desk

21660	1220mmL 48"	762mmW 30"	737mmH 29"
-------	----------------	---------------	---------------

Shelved top; lock on file drawer; cast aluminum foot with glides.

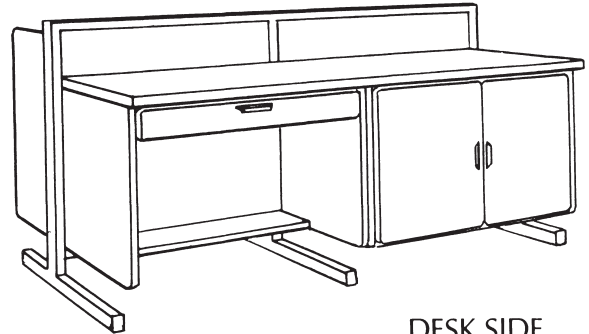

DESK SIDE

Instructors Conference Center

21665	2032mmL 80"	864mmW 34"	737mmH 29" Desk 864mmH 34" Front
-------	----------------	---------------	---

Plastic laminate top; lock on drawer; book display shelves to be adjustable.

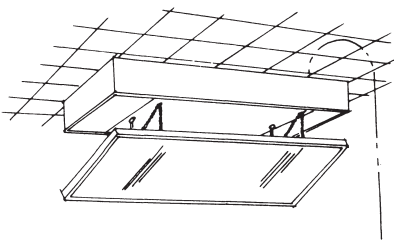

Visual Aider Mirror

22220	1680mmL 66"	864mmW 34"	337mmH 13-1/4"
-------	----------------	---------------	-------------------

Retractable demonstration mirror permits unobstructed view of table top demonstrations.

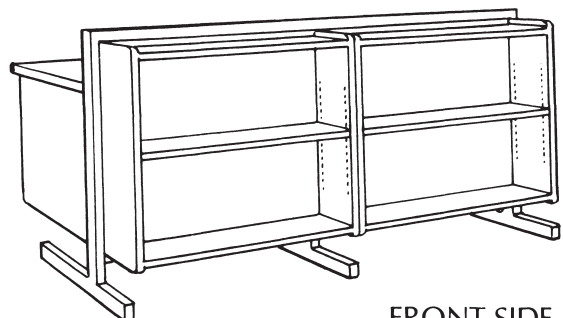

FRONT SIDE

INSTRUCTIONAL CENTERS

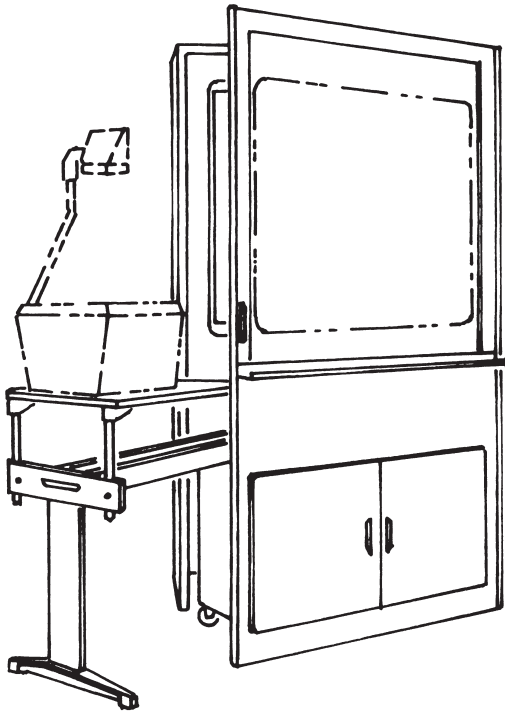

Chalkscreen Projection Center

29800 1190mmL 560mmW 2080mmH
 47" 22" 82"

When door is opened, students or instructor can write directly on images that are projected on the screen. Instructor stands beside the screen in a normal teaching manner. Room does not have to be darkened.

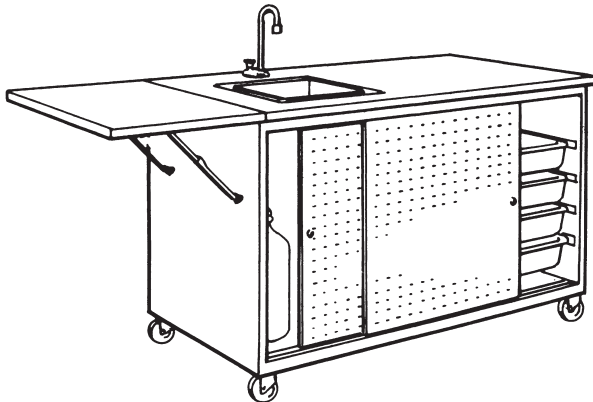

Art Material and Demonstration Center

1000G 1270mmL 610mmW 890mmH
 50" Closed 24" 35"
 1626mmL
 Open

Black plastic laminate top; drop leaf 610mm x 356mm (24" x 14"); four tray drawers; stainless steel sink 298mm x 241mm x 102mm (11-3/4" x 9-1/2" x 4"); with self priming water pump, cold water fitting, one gallon water supply and one gallon waste bottle; duplex electric outlet with 12 foot electric extension cord.

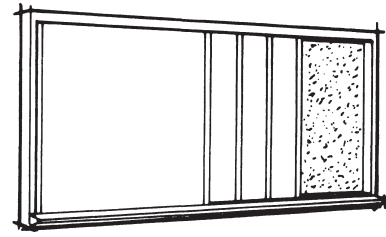

Sliding Chalkboard

22321 2438mmL 152mmW 1220mmH
 96" 6" 48"

Four green sliding boards, 990mm x 1090mm (39" x 43"); full length chalkrail; tackboard back.

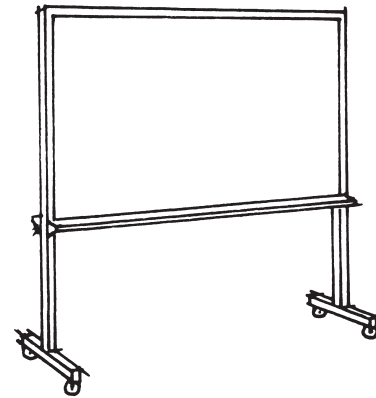

Mobile Chalkboard/Tackboard

22420 1830mmL 710mmW 1855mmH
 72" 28" 73"

Full framed chalkboard with chalkrail on one side and tackboard on opposite side; boards 1830mm x 1220mm (72" x 48"); four swivel casters, two with locking brakes.

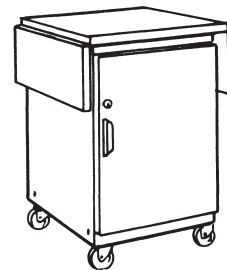

Projector Stand

22350 610mmL 610mmW 902mmH
 24" Closed 24" 35-1/2"
 914mmL
 35" Open

Plastic laminate top; two drop leaves 610mm x 152mm (24" x 6") lock on door; four swivel casters, two with locking brakes.

PAINING AND DRAWING

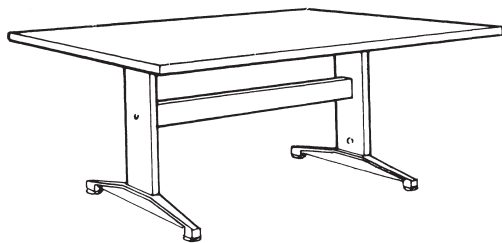
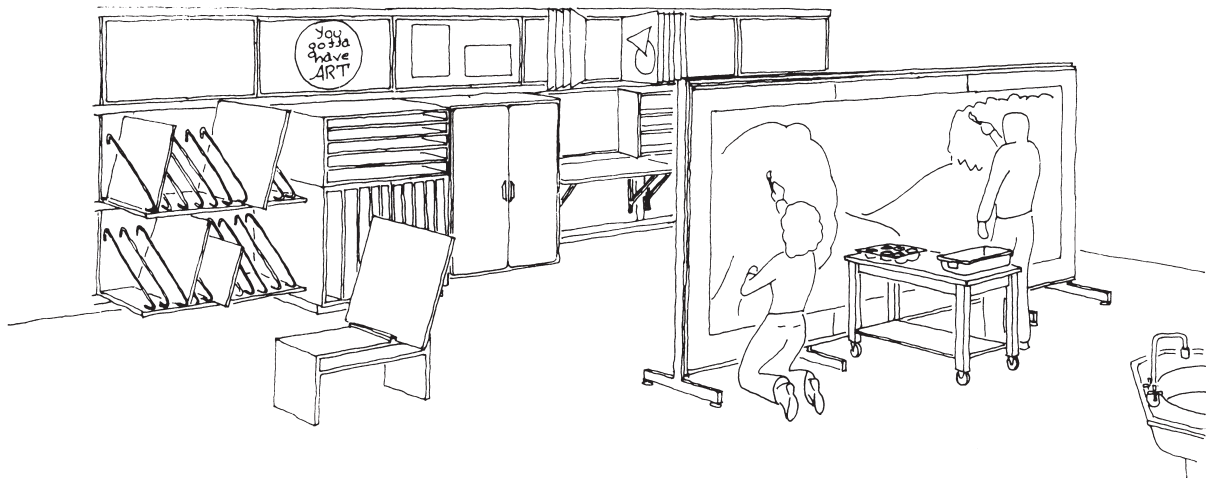

All Purpose Table

19012	1524mmL 60"	1067mmW 42"	737mmH 29"
-------	----------------	----------------	---------------

Shelweld top; solid hardwood legs and cast aluminum feet with glides. Ample over-hang of the top provides seating on all sides. Can be fitted with tote tray or carryall guides.

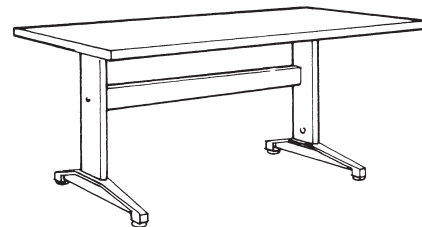

Two-Student All-Purpose Table

19013	1524mmL 60"	610mmW 24"	737mmH 29"
-------	----------------	---------------	---------------

Shelweld top; solid hardwood legs and cast aluminum feet with glides. Can be fitted with tote tray or carryall guides.

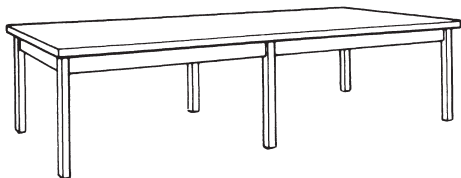

Open Frame Project Tables

53510	2032mmL 80"	1067mmW 42"	762mmH 30"
53520	2032mmL 80"	1067mmW 42"	914mmH 36"

Shelweld top; solid hardwood; heavy framed; legs corner braced construction; 915mm (36") high legs to have cross rails.

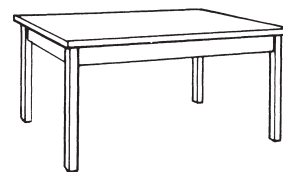

Open Frame Project Tables

53530	1524mmL 60"	1067mmW 42"	762mmH 30"
53540	1524mmL 60"	1067mmW 42"	914mmH 36"

Shelweld top; solid hardwood; heavy framed; legs corner braced construction; 915mm (36") high; legs to have cross rails.

Modeling Stand

53550	1524mmL 60"	1067mmW 42"	457mmH 18"
-------	----------------	----------------	---------------

Shelweld top

PAINING & DRAWING

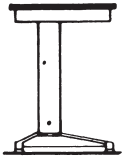
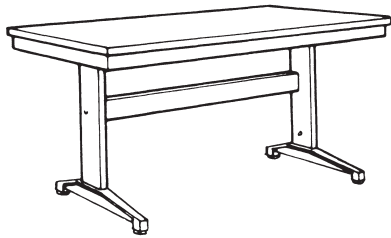

762mmH
30" Closed

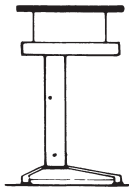

914mmH
36" Standing

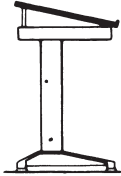

876mmH
34-1/2"
30"H Slope

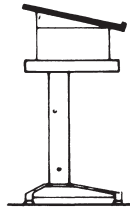

1022mmH
40-1/4"
36"H Slope

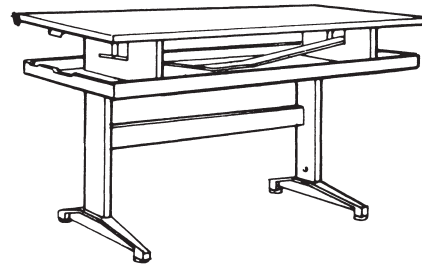

Bi-Level Project Center

19903 1372mmL 1372mmW 762mmH
54" 20" 30" Closed

Shelweld top; top adjustable from level sitting height to: (1) level standing height, (2) sloping sitting height, or (3) sloping standing height, solid hardwood legs and cast aluminum feet with glides. Bi-Levels are versatile, unique. Two students easily change the top height and position to accommodate the activity like level for drawing, writing or sloped for photography layouts, tracing, painting. When space is limited, the Bi-Level serves many art education functions.

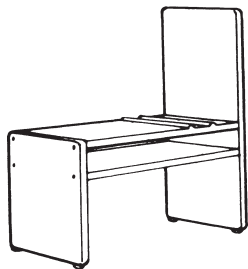

Art Horse

18950 711mmL 305mmW 838mmH
28" 12" 33"

Solid hardwood. Ideal for sketching, drawing, painting. Easily carried to the patio for outdoors use. The wide feet increase stability over earlier designs.



Adjustable Top Art Center

18296 1067mmL 533mmW 737mmH
42" 21" 29"

Plastic laminate top; top adjustable to almost vertical; front edge with sliding rail; solid hardwood legs and cast aluminum feet with glides. Can be fitted with tote tray or carryall guides.

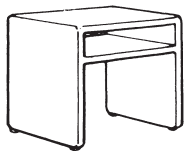

Art Bench

18955 432mmL 305mmW 432mmH
17" 12" 17"

Solid hardwood. Provides student seating in keeping with the utility and functions necessary in the Art Studio. The shelf solves the problem of storing transient materials, otherwise placed in the way on the table top, or piled on the floor.

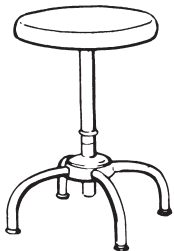

Art Stool

18958
Metal stool; 330mm (13") diameter seat, adjustable from 483mm to 686mm (19" to 27").

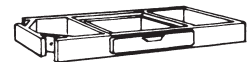

Kneespace Frame

54590 102mmL 559mmW 127mmH
40" 22" 5"

Solid hardwood; four sided full framed, corner braced construction. Other sizes available upon request.

54595 102mmL 559mmW 127mmH
40" 22" 5"

Same as #54590 except with drawer

Drawer 450mm x 455mm x 65mm (17-5/8" x 18" x 2-5/8")



Single Leg

56251 711mmH
28"

Solid hardwood; fitted with composition shoe.

Double Leg

56271 889mmH
35"

Same as single leg, except to have cross rails.



WORK BENCHES & ROLL PAPER STORAGE

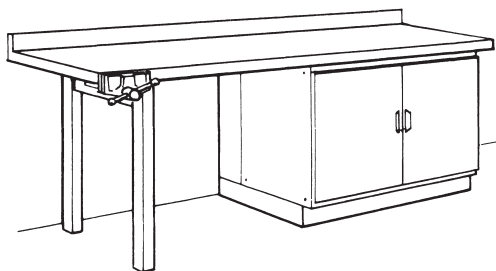

Craft Project Bench

18933 1830mmL 610mmW 914mmH
 72" 24" 36"
 32mm (1-1/4") Shelweld top, #86435 medium duty clamp vise, #36010 bolt-reinforced cupboard cabinet.

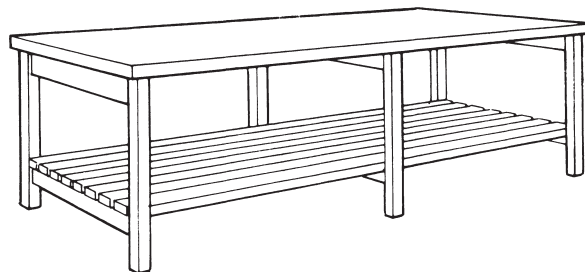

Heavy Duty Project Benches

53570 2433mmL 1067mmW 914mmH
 96" 42" 36"

32mm (1-1/4") Shelweld top. Shelf provides storage of 2134mm to 762mm (84" to 30") flat stock. These benches are ideal for large project layout work, or for mounting vises, grinders, jig saws, drill press, etc.

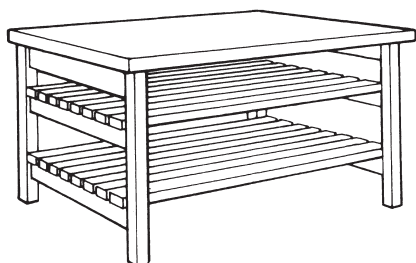

Heavy Duty Project Benches

53560 1524mmL 1067mmW 914mmH
 60" 42" 36"

32mm (1-1/4") Shelweld top, solid hardwood, thru-bolted construction; two solid hardwood slatted shelves. Shelves provide storage for large quantities of 1219mm x 762mm (48" x 30") flat stock.

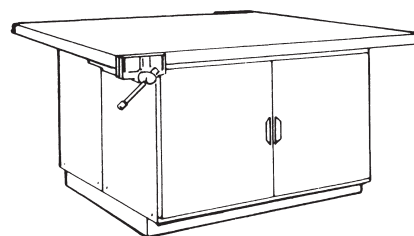

Craft Project Bench

27475 1220mmL 1220mmW 914mmH
 48" 48" 36"

32mm (1-1/4") Shelweld top, #86435 medium duty clamp vise, #36010 bolt-reinforced cupboard cabinet.

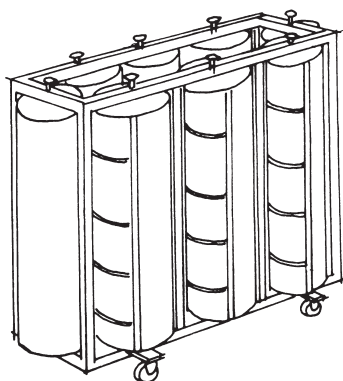

Roll Paper Dispenser

46708 991mmL 559mmW 1168mmH
 39" 22" 46"

Metal frame; eight roll paper holders each with tear bar for paper rolls up to 914mm (36") wide; four swivel casters.

STACKABLES, 2-D DIVIDERS & DRYING RACKS

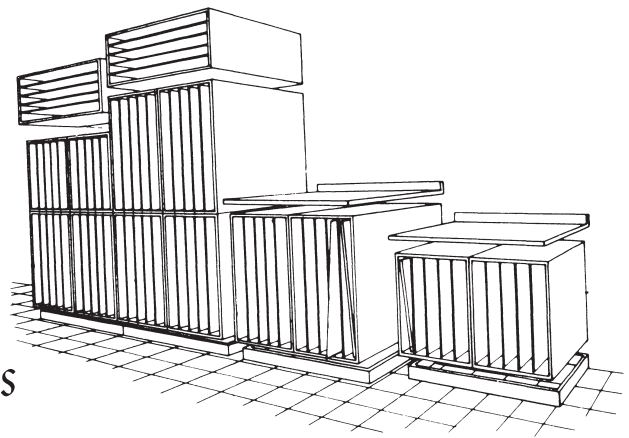
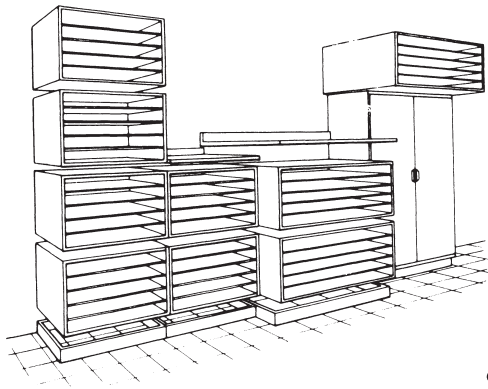

STACKABLES

Stackables are designed for specific 2D storage, and are needed in every Art Studio. You can “stack ‘em” as best suits your needs. When used as “Horizontals” they are for paper storage, poster-board storage, including sheets up to 762mm x 1016mm (30” x 40”). When used as “Verticals” they are ideal for storing student

paintings in process and for drawing boards. As illustrated, there are many ways to place Stackables in the Art Studio. Bolting Stackables to the top of tall standard storage cases is an excellent way to conserve space, yet give good access to stored materials. Each Stackable has five compartments.

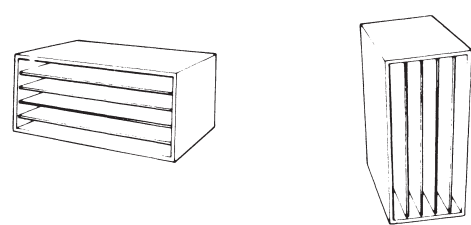
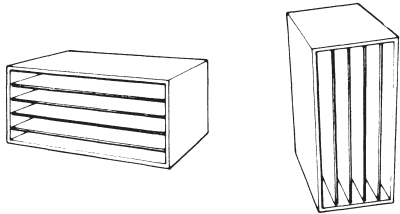

Stackable

46620 813mmL 533mmW 533mmH
 32” 21” 21”

Heavy duty, all wood construction. Designed to accommodate materials up to 762mm to 508mm (30” to 20”).

Stackable

46630 1067mmL 787mmW 533mmH
 42” 31” 21”

Heavy duty, all wood construction. Designed to accommodate materials up to 1016mm to 762mm (40” to 30”).

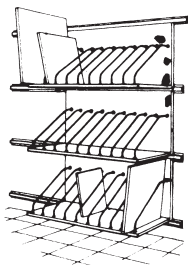

2D DIVIDERS

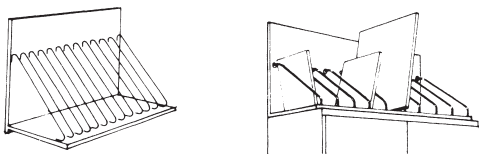

2D Vertical Divider

46640 840mmL 483mmW 711mmH
 33” 19” 28”

Sheltex panel forming a 90° angle for mounting 13 metal dividers, set approximately 57mm (2-1/4”) apart. The entire board is secured in rails and yet can be lifted out, carried to work areas. Tops of tall storage cabinets serve as ideal places to permanently locate dividers.

AWT 100-Shelf Portable Drying Rack

This is an all-welded-steel wire rack with gray enameled finish, mounted on 2” ball casters. Its mobility makes it ideal for use in schools, print and sign shops, art studios, or home hobby areas. It has 100 stationary shelves, size 10” x 18” (25 cm x 46 cm), 50 on each side, spaced 1” apart. Mesh size is 6” x 10” (15 cm x 25 cm). Up to 100 sheets of paper, cardboard, or plastic can be dried or stored on this unit. The base measures 19” x 22” (48 cm x 57 cm) unassembled. Shipping weight is 75 lbs.

DISPLAY

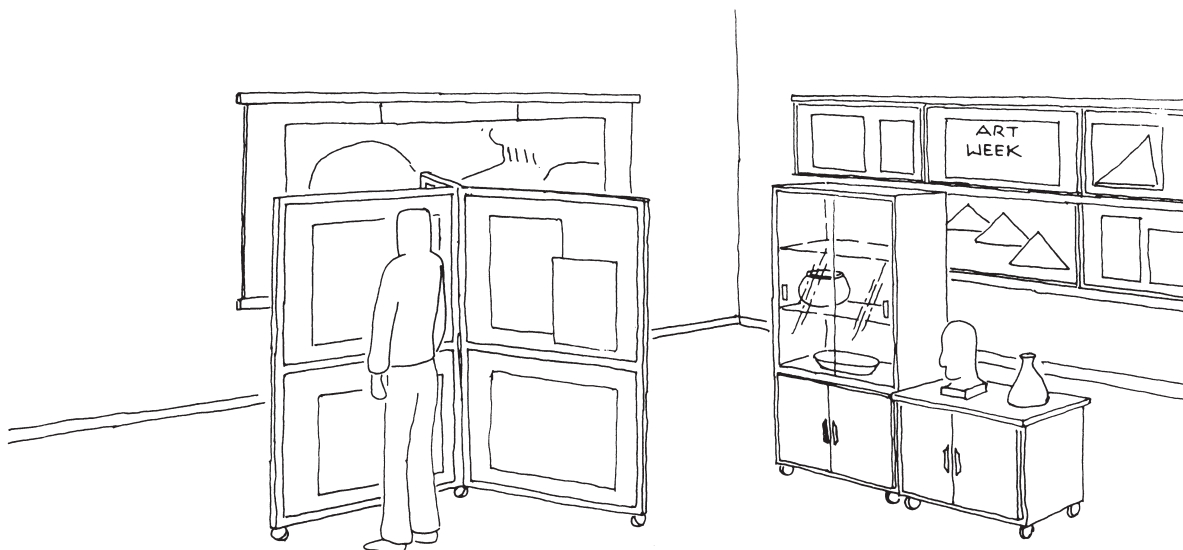

Display facilities are very important for they allow student work to be an inspiration to others. Within the catalog there are other items that serve display

areas. The display scene portrays some of these additional types of display items.

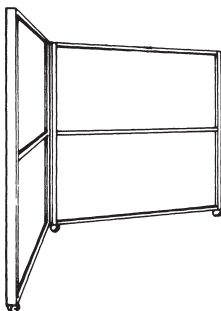

Display Panelwall

DPW-1 325.1cmL 51mmW 1612mmH
10'8" 2" 63-1/2"

Two-section panelwall assembly; two #7182-31 panelwalls with in line couplers and 90° angle stabilizer; four #7182-21 tackboards with vinylcork on both sides.

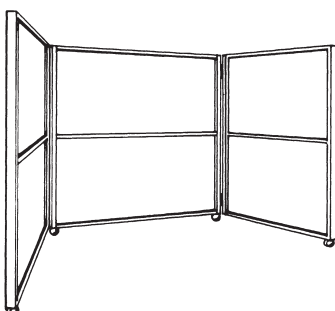

Display Panelwall

DPW-2 447.0cmL 51mmW 1612mmH
14'8" 2" 63-1/2"

Three-section panelwall assembly; three #7182-31 panelwalls with in line couplers and 120° angle stabilizers; six #7182-21 tackboards with vinylcork on both sides.

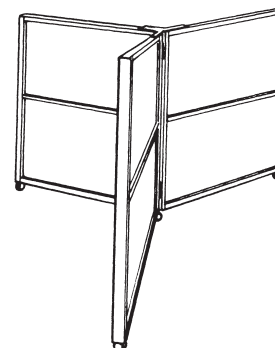

Display Panelwall

DPW-4 289.6mL 289.6mW 1612mmH
9'6" 9'6" 63-1/2"
Overall Overall

Tri-section panelwall assembly; three #7182-31 panelwalls with tri-wall couplers and tri-wall stabilizer; six #7182-21 tackboards with vinylcork on both sides.

DISPLAY

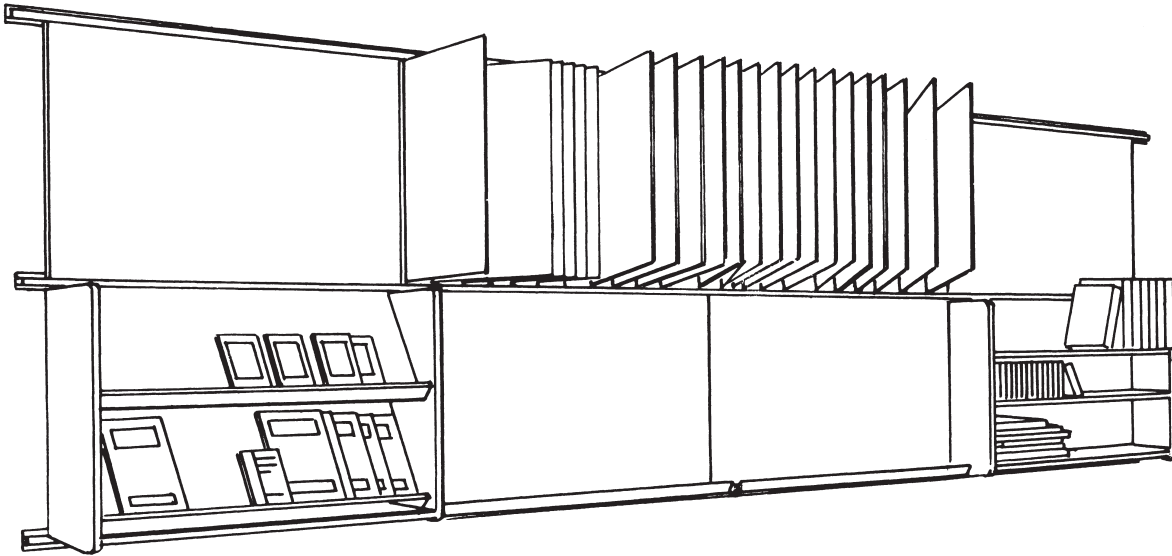

PICTURE HANGING DEVICES Complete Picture, Print, Panel Display System

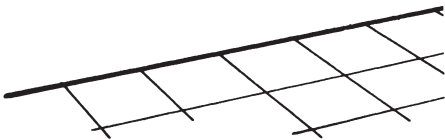

Spacer Rod

3290-18 adjusts from 457mm to 965mm (18" to 38")
3290-36 adjusts from 914mm to 1422mm (36" to 56")
Keeps the hanger rods from "pulling together" under weight of picture.

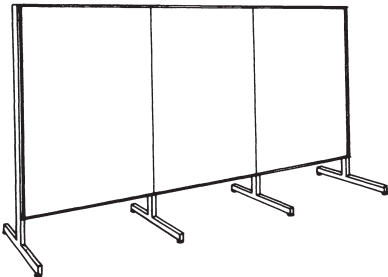

Mural Display Station

DLP-1 3,124mmL 914mmW 1727mmH
 123" 36" 68"

3 #7188-33 Mural Panels supported on one #EC 7203-44 and 2 #EC 7203-48 Relocatable Support Rails. Ideal for securing large 2D work material can be nailed, stapled, or taped to panel.

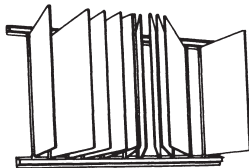

Hi-Density Display

DLP-2 1219mmL 762mmW 737mmH
 4'0" 30" 29"

2D compact display assembly. One #7201-38 mounting rails; one #7201-11 support rails, fifty #7185-11 display panels; twenty-five #7186-00 hinged panel posts.



Hanger Rod

3180-27
Fiberglass hanger rod 686mm (27") long; locks into outer "C" track; hooks, holders and clips attach to hanger rod to hold media to be displayed.



Plain Rod

3130-27
Fiberglass rod 686mm (27") long; held on the support rail with a Dual Rod Holder and may extend both above and below rail. Two rods fully extended can hold several smaller works, one above the other. When used to hold one painting, print or panel, remains totally concealed when the length of rod(s) is not greater than the vertical dimension of the work.



Dual Rod Holder

3440-00
Holds one or two plain rods. When rod extends at least 51mm (2") above support rail, the holder locks on the mat or panel, also allows mat and panel to extend above support rail.



Panel (Print) Holder

3320-12 Panel and mats up to 6mm (1/4") thick
3320-13 Panel and mats up to 10mm (3/8") thick
3320-14 Panel and mats up to 13mm (1/2") thick
3320-15 Panel and mats up to 16mm (5/8") thick
Supports the bottom and top edge of all sizes of matted prints, photos and long panels.

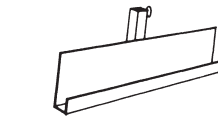

Long Holder

3330-53
Supports the bottom and top edge of any mat or panel up to 10mm (3/8") thick

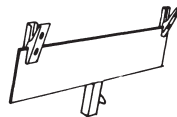

Twin Clips

3340-82
Grips the top edge of works up to 5mm (3/16") thick. Excellent for hanging works that need support at several locations on their top edge.

Side Arm Holder

3310-02
In combination with Panel Holders, keeps large matted work from bowing.



Level Hang Hook

3250-00
Used with two Hanger Rods, provides two point support for large framed works.

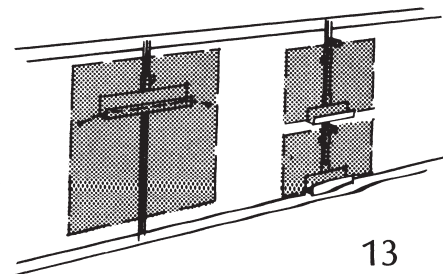

STUDENT WORK TOWERS

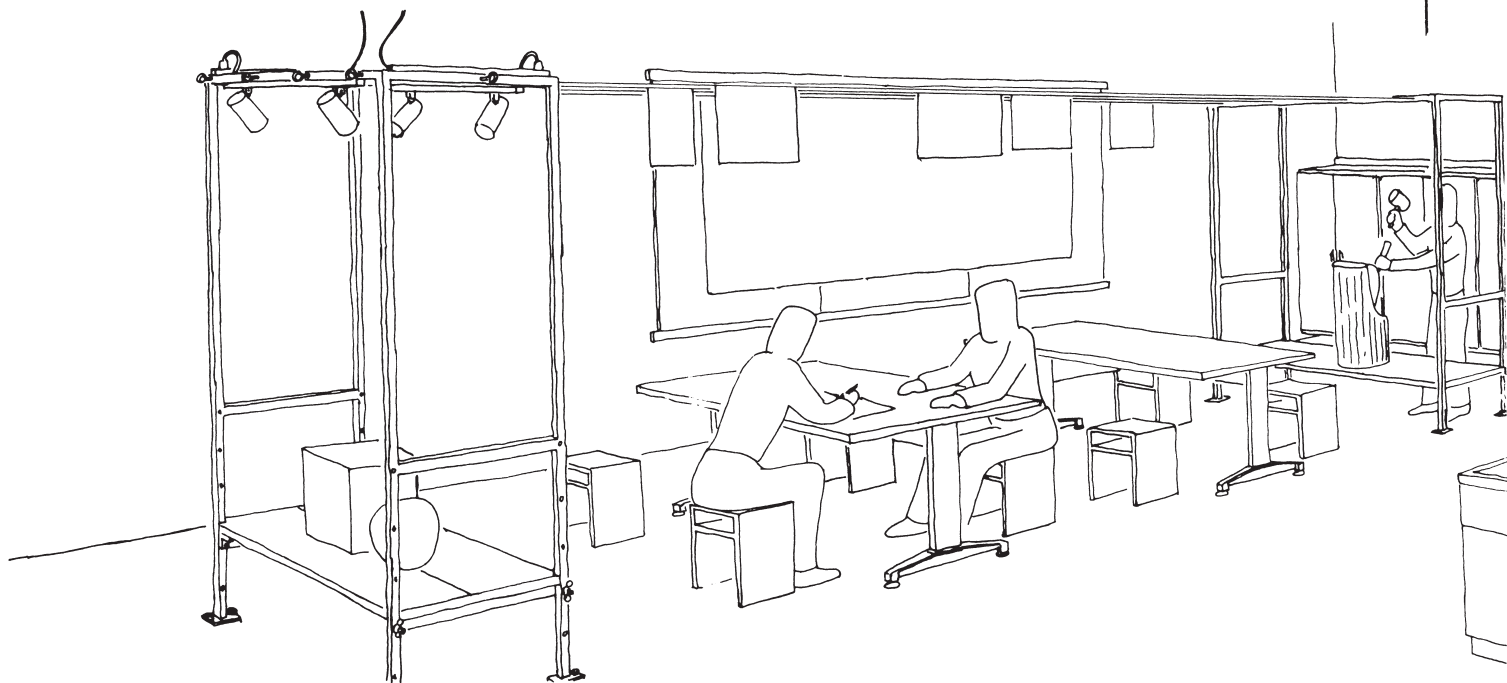

Student Work Towers Inspection of numerous recommended Art Studios established the need for a specialized work center that could serve universal purposes applicable to many art activities.

The Student Work Towers create multi-purpose work centers and bring a third dimension to the Art studio rarely available. Work Towers are secured to the floor, becoming a rigid stationary tower. Work Towers allow ceiling type art activities; can become a modeling platform; with track lights they permit casting sha-

dows on models; wood sculpture platform can be created. By using clamps, frames may be secured for weaving, looms, tapestry, sign boards, and mural panels. By locating two Towers in a Studio, properly spaced, tight wires may be strung between the Towers. 2-D work, textiles, etc. can be hung to dry or to display. Electricity, supplied through power adapters eliminate unsightly ceiling drop cords.

Art Educators and students will discover other ingenious uses for these new concept Student Work Towers.

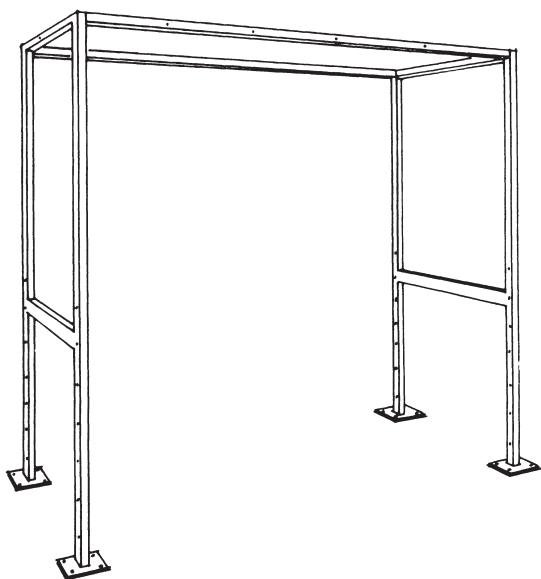

Student Work Tower

79900	2134mmL 84"	752mmW 30"	2134mmH 84"
-------	----------------	---------------	----------------

Heavy gauge, square tubular frame with feet for fastening to floor; bolt holes on 152mm (6") centers from 152mm to 1067mm (6" to 42") above the floor; top frame with four bolt holes on each side, one on each end, to accept accessory items.

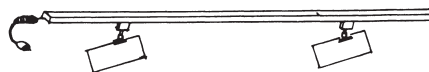

Tower Track Light Systems

7266-40	1829mmL	254mmW	254mmH
	72"	10"	10"

Two baffled R-40 light cylinders; 1829mm (72") long single circuit lighting track and 1219mm (48") cord.



Tower Light Cylinders

7266-41

Baffled R-40 spot light with T-bar mounting to light track.



Tower Support Rail

7266-42	762mmL	51mmW	51mmH
	30"	2"	2"

90° angle steel support rail, in-line couplers.



Tower Bolt Hook

7266-43

Locks into holes on top of Tower to accommodate tight wires. Tight wire can be strung between Towers or Tower to EC Support Rails.

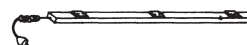

Power Adapter

7266-44	762mmL	32mmW	25mmH
	30"	1-1/4"	1"

762mm (30") long, three outlet with cord.

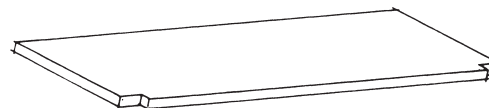

Tower Modular Boards

7266-45	2134mmL	38mmW	32mmH
	84"	15"	1-1/4"

32mm (1-1/4") Shelweld Board with two end notches. Used in conjunction with tower support rails can be used at various heights from 152mm to 1067mm (6" to 42") above the floor.

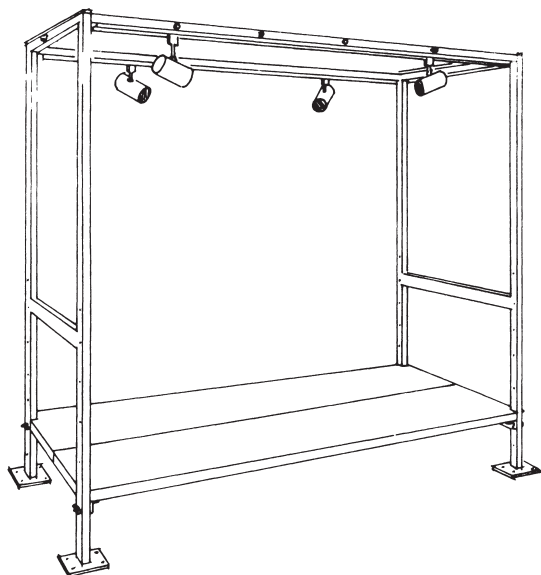

Student Work Tower

79901	2134mmL	762mmW	2134mmH
	84"	30"	84"

Same as #79900, except with additional items; two #7266-40 tower track light systems; two #7266-44 Power adapters; four #7266-42 tower support rails; ten #7266-44 tower bolt hooks; two #7266-45 tower modular boards.

CERAMICS

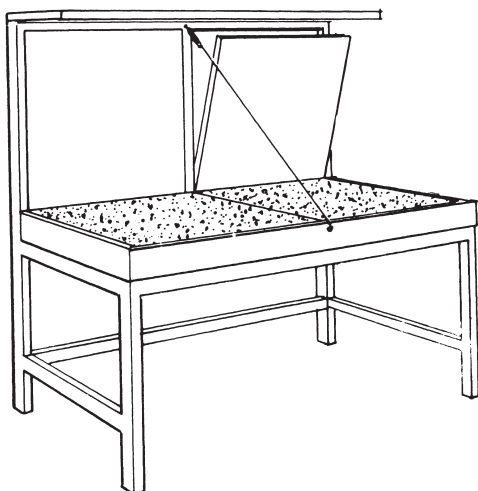
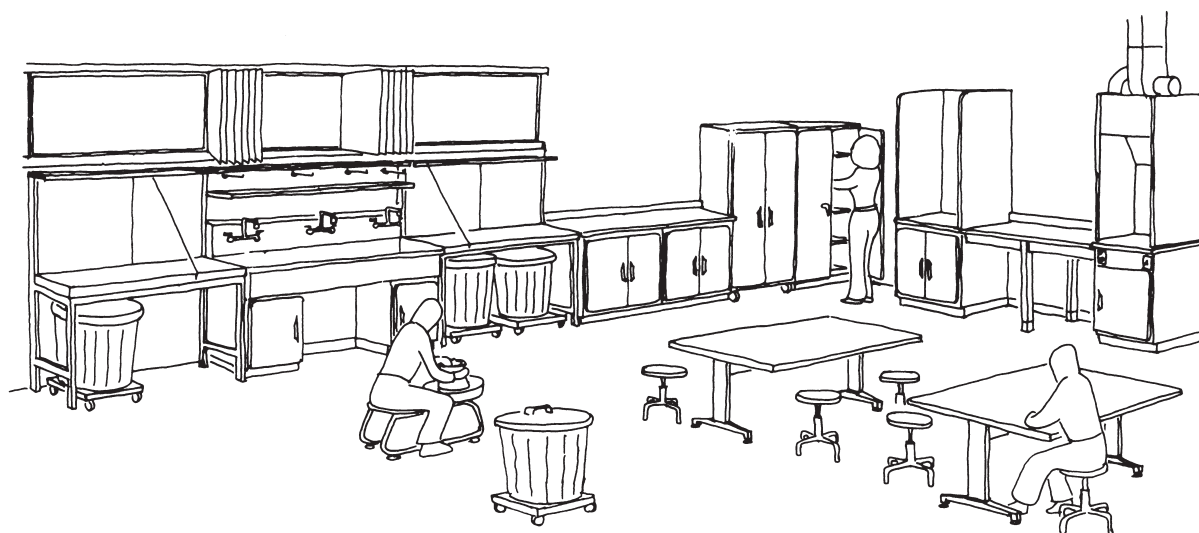

Wedging/Sculpture Station

79910	1219mmL 48"	660mmW 26"	914mmH 36" to counter 1549mm 61" Back
-------	----------------	---------------	--

2 Student; solid hardwood, thru-bolted frame; top formed of heavy metal pan designed to contain smooth finished hard cement; stainless steel for cutting clay; drop down secondary top creates ideal surfaces for clay slab and clay sculpture work and also as backboard for wedging operations. Cement not included.

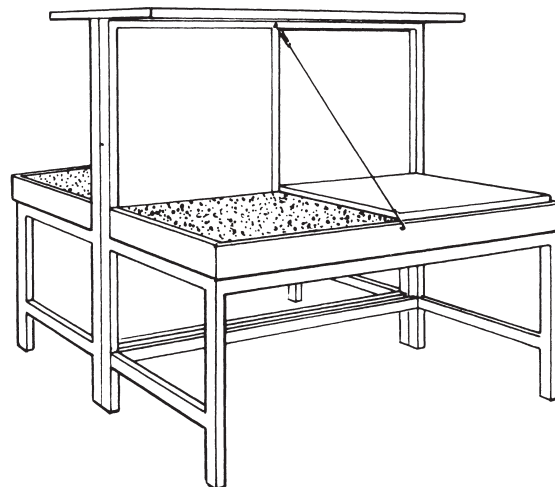

Wedging/Sculpture Station

79915	1219mmL 48"	1333mmW 51-1/2"	914mmH 36" to counter 1549mm 61" Back
-------	----------------	--------------------	--

Same as #79910 except designed for four student use.

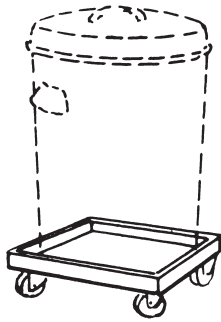

Glazing/Clay Materials Mobile Stand

79930 457mmL 457mmW 127mmH
 18" 18" 5"

Welded steel frame; 19mm (3/4") thick solid bottom; four swivel casters. Designed to accept either glazing or clay material storage containers. Supports up to 227 kg. (500 lbs.).

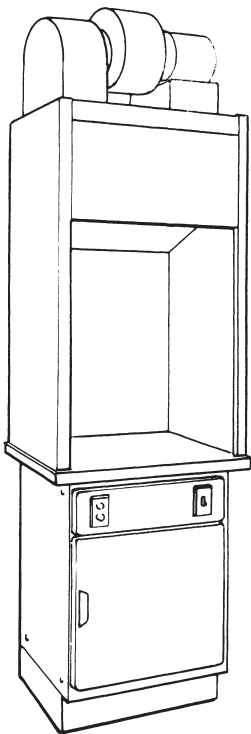

Spray Booth

79950 635mmL 610mmW 2089mmH
 25" 24" 82-1/4"

Metal with baked on enamel finish superstructure, front opening 838mm (33") high; fan and light switch; vaporproof light, 152mm (6") exhaust fan with 1/8 H.P. motor; 110V AC electric receptacle in the cabinet front apron; #77350 base cabinet. Requires exhaust duct to the building exterior. Ventilation is necessary for such operations when an air compressor or spray gun is used, when toxic materials are employed or when the volume of finish and hazards dictate a need for mechanical air exhaust.

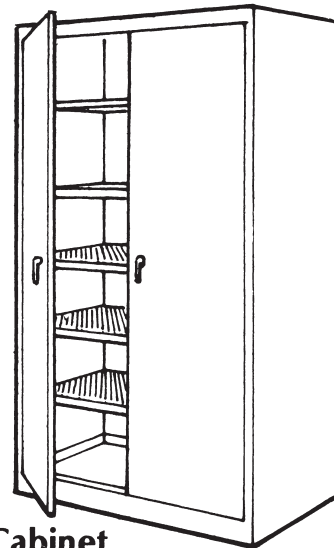

Damp Cabinet

79920 914mmL 457mmW 2159mmH
 36" 18" 85"

Heavy duty metal cabinet; doors completely incased in their own frame, three point latching; five adjustable perforated shelves; bottom is an inverted pan 25mm (1") deep, in which a layer of plastic or clay can be placed to absorb water for a damp box effect.

For storage of clay projects during the drying period, use metal shelving with expanded metal shelves as shown on page 27.

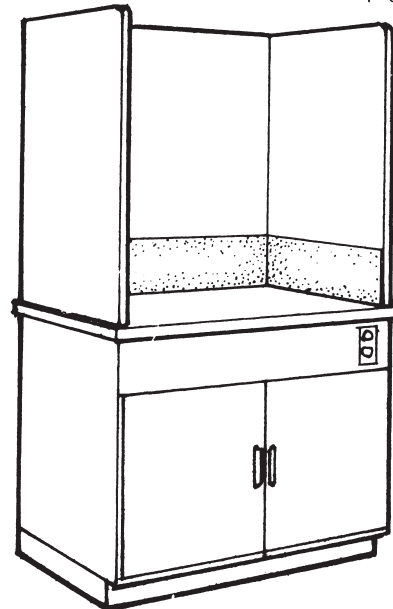

Glazing Booth

79940 1245mmL 610mmW 2102mmH
 49" 24" 82-3/4"

This Glazing Booth has wide application in serving the finishing needs for Art. The superstructure is open full height of front and top. It is equipped with galvanized metal covered counter top working surface and interior liner 10" high. This superstructure may be easily lined with Kraft Paper or Homasote Board, providing an interior that can be quickly and inexpensively replaced when it becomes soiled and unattractive.

Finishing by blow tube, hand sprayer, or brush involves little finish being released to the room atmosphere, and does not require mechanical means of air exhaust. This assembly provides a roomy superstructure adequate to these techniques. This superstructure is also ideal as an area for spatter work with ink and toothbrush and other means.

The base cabinet provides a cupboard with one adjustable shelf, for storage of materials and equipment.

STUDIO SINKS

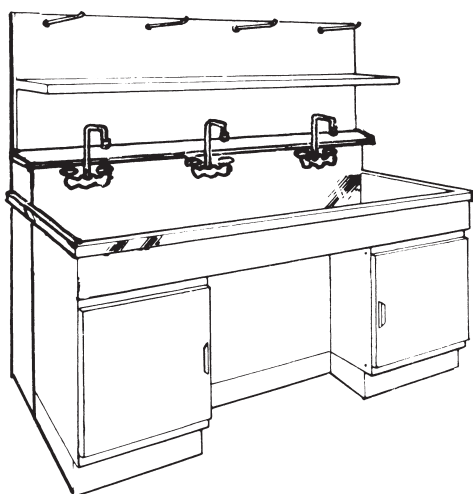

Wall Sink Center

76810 1880mmL 762mmW 1549mmH
74" 30" 61"

Type 302, stainless steel basin 1829mm x 559mm x 203mm (72"x22"x8") I.D.; #73290 Art Service Turret; #73285 Art Sink Service Wall; two #39100 base cabinets with closure panel.

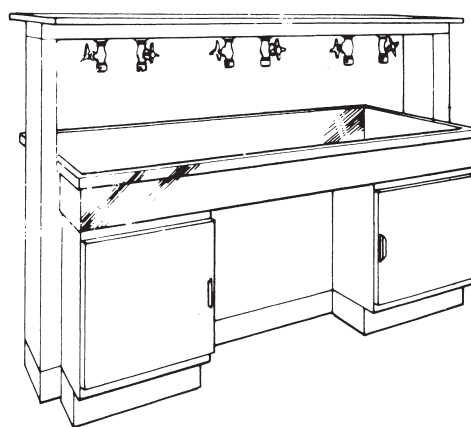

Island Sink Center

76820 2184mmL 610mmW 1372mmH
86" 24" 54"

Type 302, stainless steel basin, 1829mm x 559mm x 203mm (72" x 22" x 8") I. D.; six #80440 cold water fittings each with #81020 aerator; service turret 2184mm x 152mm x 1372mm (86" x 6" x 54") with plastic laminate top; two #39100 base cabinets with closure panels.

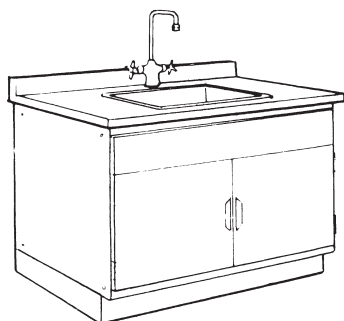

Wall Sink Center

76850 1245mmL 610mmW 914mmH
49" 24" 36"
to counter

Plastic laminate top and 102mm (4") high rear curb; #78670 stainless steel sink; #80100 hot and cold water mixing fitting, with #81020 aerator; #77260 sink cabinet.

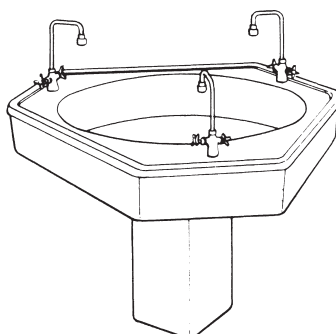

Trifacial Sink Center

76240 1200mm (47") from side to side
in all three dimensions

One-piece formed sink and counter with raised marine edge; basin 914mm (36") diameter x 196mm (7-3/4") deep I.D.; completely enclosed understructure of molded glass reinforced structural polyester, mandarin red in color, access panel below service fittings; pedestal of formed steel with removable access panel; three #80100 hot and cold water mixing fittings each with #81020 aerator.

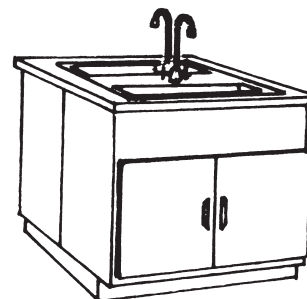

Island Sink Center

76840 1245mmL 1219mmW 914mmH
49" 48" 36"

Plastic laminate top two #78670 stainless steel sinks; two #80100 hot and cold water mixing fittings; each with #81020 aerator; two #77260 sink cabinets.

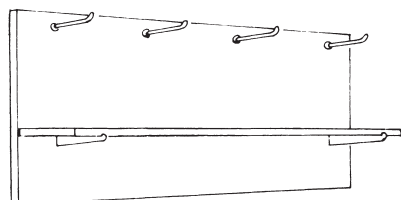

Art Sink Service Wall

73285 1880mmL 229mmW 533mmH
74" 9" 21"

Plastic laminate back panel with shelf 1880mm x 203mm (74" x 8") and four hooks 229mm (9") long.

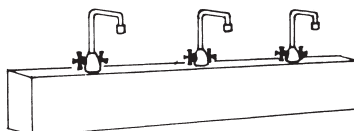

Art Service Turret

73290 1880mmL 152mmW 102mmH
74" 6" 4"

Plastic laminate service turret; three #80100 hot and cold water mixing fittings each with #81020 aerator.

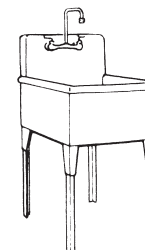

Quench Sink

76830 686mmL 610mmW 686mmH
27" 24" 27"

Steel, galvanized with zinc seamless welded construction; supported on angle legs with hold-down clips for bolting to floor; back 305mm (12") H; #80250 cold water fitting.

PHOTOGRAPHY

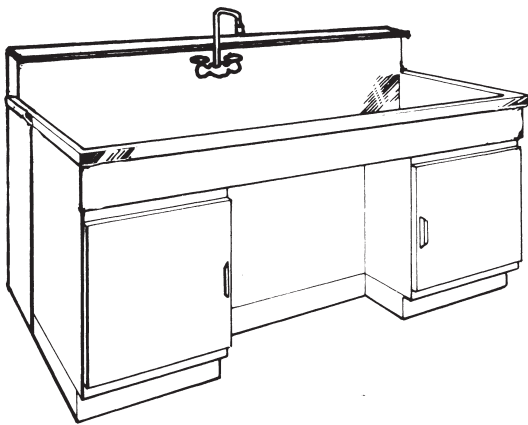
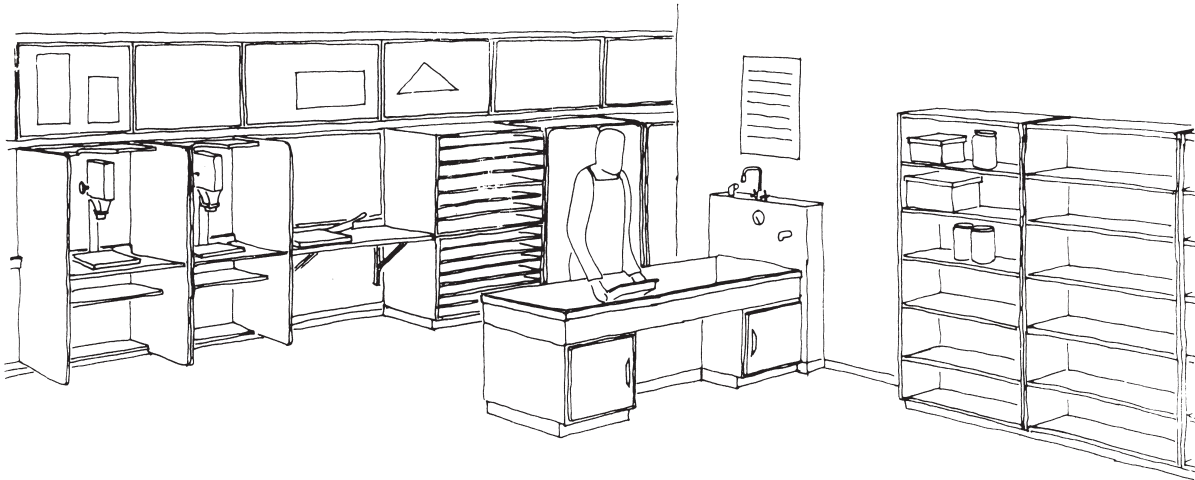

Wet Processing Photographic Developing Center

76900 1880mmL 762mmW 1016mmH
 74" 30" 40"

Type 316; stainless steel basin 1829mm x 559mm x 203mm (72" x 22" x 8") I.D.; service turret 1880mm x 152mm x 1016mm (74" x 6" x 40") with #80100 hot and cold water mixing fitting only; turret designed to permit addition of other fittings, temperature blenders and gauges as desired; two #39100 base cabinets with closure panels.

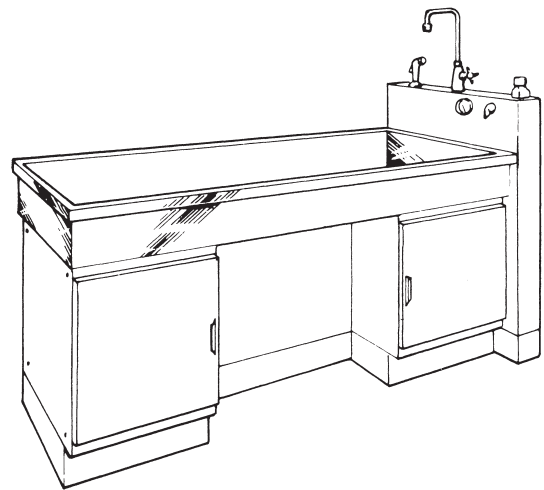

Wet Processing Photographic Developing Center

76910 2032mmL 610mmW 1016mmH
 80" 24" 40"

Same as #76900 except service turret 610mm x 152mm x 1016mm (24" x 6" x 40").

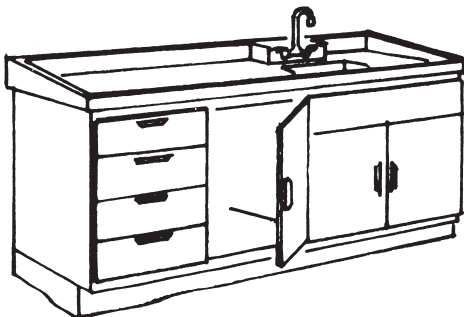

Wet Processing Photographic Developing Center

27825 1790mmL 610mmW 914mmH
 70-1/2" 24" 36" to
 counter top

Counters sloped to integral basin 455mm x 300mm x 127mm (18"x12"x5") I.D.; raised edges and covered corners to retain spilled materials and liquids; top assembly of one-piece molded glass reinforced structural polyester twilight in color; #80300 hot and cold water mixing fitting; #77270 sink cabinet, #36060 storage cabinet; #37060 drawer cabinet.

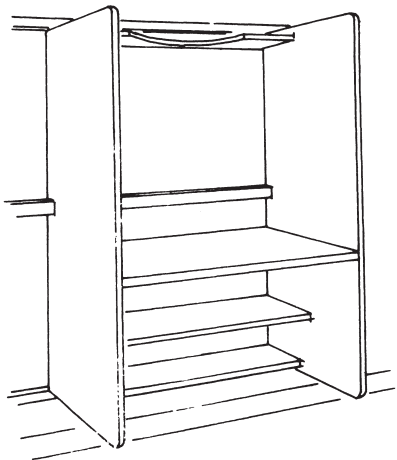
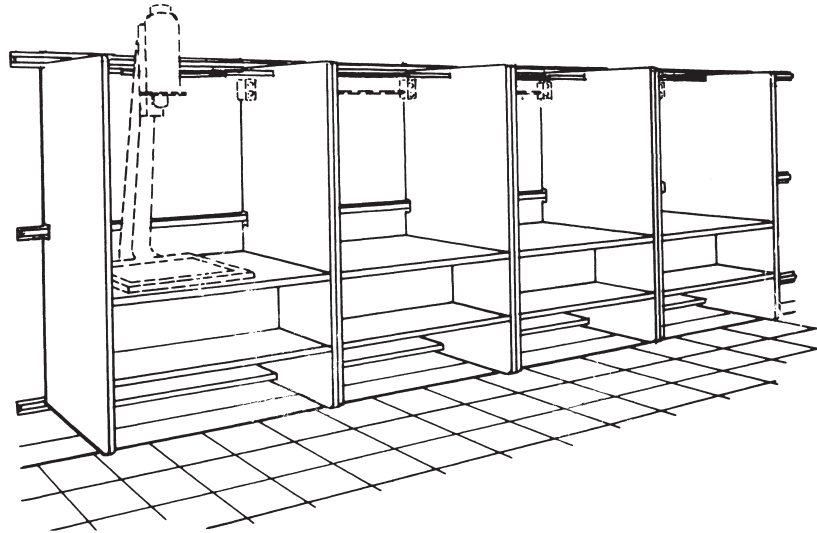

Enlarger Booth

74100 762mmL 762mmW 1422mmH
30" 30" 56"

Sheltex superstructure is open full height; plastic laminate countertop; below one fixed shelf and foot rest.

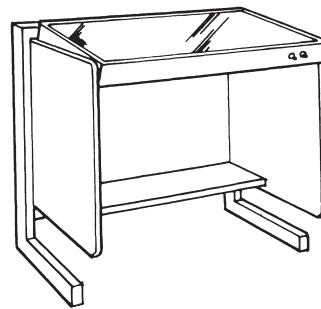

Light Table

27490 1092mmL 660mmW 939mmH
43" 26" 37"

Metal frame construction; plastic laminate shell with integral top and foot rest; light box with heavy glass work surface; completely uniform light diffusion; adjustable from level to 7° working angle. Ideal for tracing, layouts, stripping, film inspection, photogrammetry, opaquing, and others.

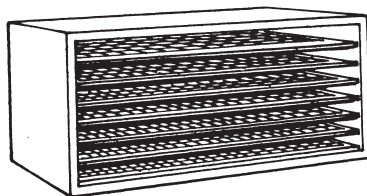
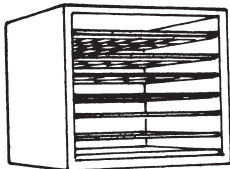

Print Drying Racks

46645	508mmL	483mmW	711mmH
	20"	19"	28"
46646	1016mmL	483mmW	711mmH
	40"	19"	28"

Sheltex panel frame construction; seven full depth and width light weight pullout removable frames; frames of perforated screen with enameled metal trim; screen of plastic material to withstand corrosion; frames rest on full length rails.

JEWELRY & SCULPTURE

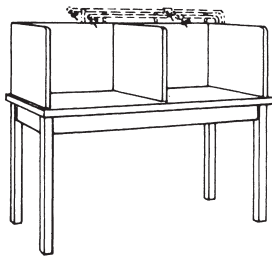
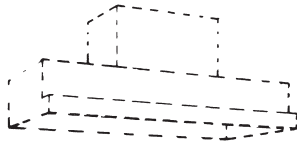
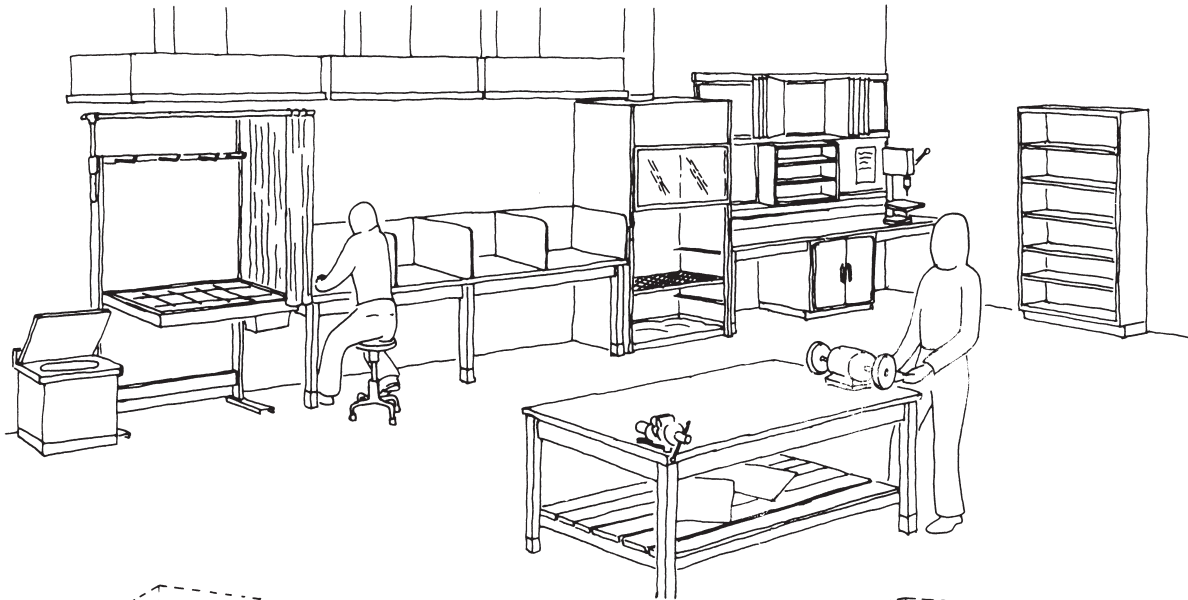

Jewelry Station

53400 1524mmL 610mmW 1372mmH
 60" 24" 54"
 914mmH
 36" to counter

32mm (1-1/4") Sheldine top, back wall and divider; two stations each 762mm x 610mm (30" x 24") solid hardwood, thru-bolted frame construction.

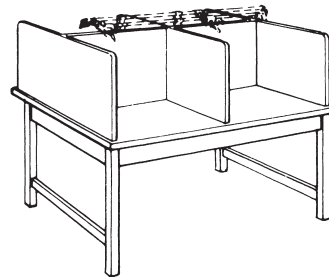
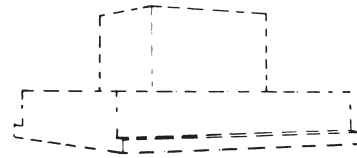

Jewelry Station

53410 1524mmL 1219mmW 1372mmH
 60" 48" 54"
 914mmH
 36" to counter

Same as #53400, except designed for four stations.

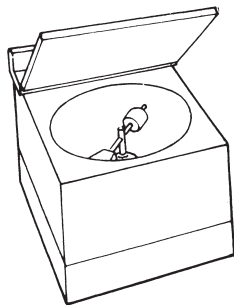

Centrifugal Casting Well

33900 584mmL 584mmW 248mmH
 23" 23" 9-3/4"

Sheltex panel gives full access to centrifugal casting machine; stainless steel basin 533mm (21") diameter x 305mm (12") deep.

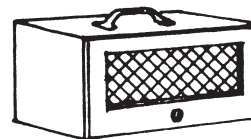

Acid Bottle Carrier

33901 381mmL 203mmW 254mmH
 15" 8" 10"

Sheltex panel construction; formed wire mesh door with lock; removable acid resisting synthetic pan approximately 305mm x 152mm x 51mm (12" x 6" x 2").

JEWELRY & SCULPTURE

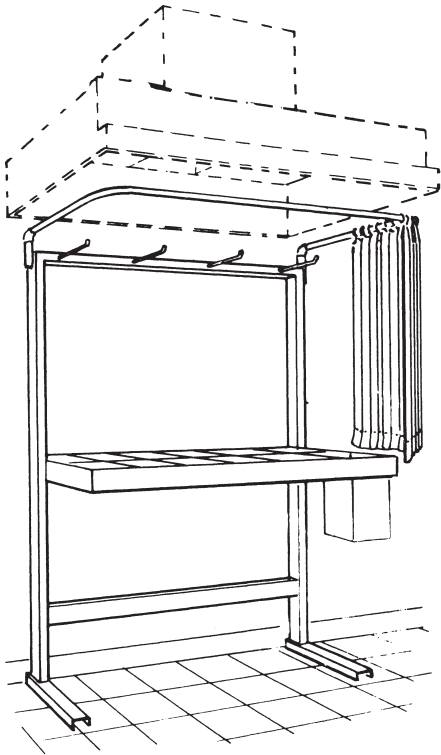

Sculpture Station

99800	864mmL 34"	521mmW 20-1/2"	1562mmH 61-1/2"
-------	---------------	-------------------	--------------------

Rugged welded construction, 76mm (3") channel with steel support braces; washable fire retardant curtain 1524mm x 1219mm (60" x 48") and adjustable curtain rod assembly, steel pan to receive 12 standard fire backs and steel quench tank, back panel of fire resistant fiber material. Fire bricks are included.

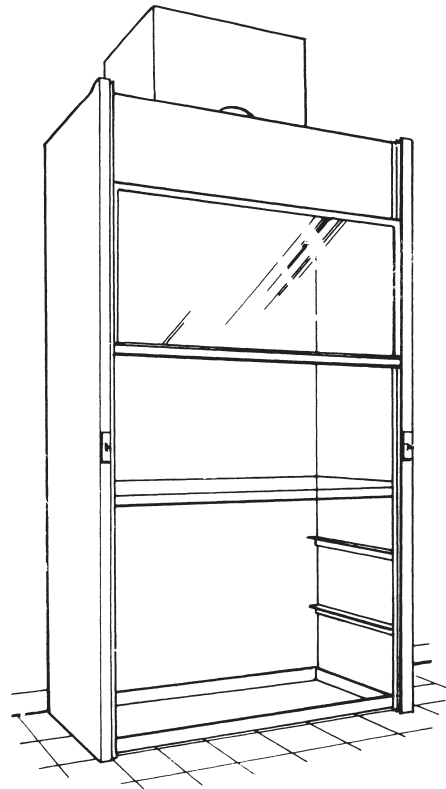

Burn-Out Booth

99810	1219mmL 48"	610mmW 24"	2591mmH 102"
-------	----------------	---------------	-----------------

Adjustable counter is full inside length and width, 32mm (1-1/4") thick. Adjustable at 305mm (12"), 610mm (24"), and 914mm (36") from the floor. Counter is made of 16 ga. flattened expanded metal opening 6mm (1/4") x 25mm (1"). The hood is constructed of 18 ga. Galvanized Steel with epoxy finish. A 51mm (2") deep pan is provided at the floor. Front full height corner posts are 51mm (2") x 51mm (2"). Each post encloses an electric switch. One for the vapor proof incandescent, one for the blower. Blower is not included. The exhaust duct collar is 203mm (8") diameter. Clear laminated safety glass sash has a continuous finger lift. Sash is 610mm (24") high, and operates by means of an enclosed spiral balance in the sash guide. The sash raises 457mm (18") to maximum of 1981mm (78") above the floor.

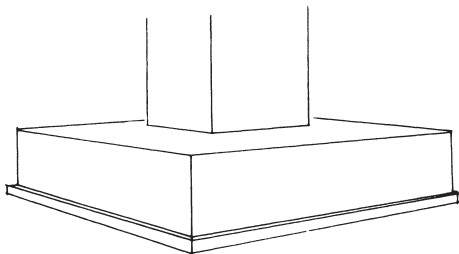

Canopy Hood

99820	1219mmL 48"	686mmW 27"	305mmH 12"
-------	----------------	---------------	---------------

Enamel steel construction; two integral blowers, single transit to 304.8mm (12") diameter duct stub; two fluorescent lights.

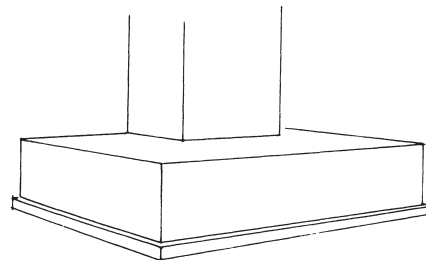

Canopy Hood

99830	1219mmL 48"	1219mmW 48"	305mmH 12"
-------	----------------	----------------	---------------

Same as #99820, except with four integral blowers; two transits to two 304.8mm (12") diameter duct stubs.

MOBILE STORAGE

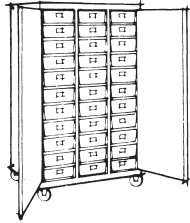

Drawer Tray Handling and Storage

69683 1194mmL 550mmW 1550mmH
47" 21-5/8" 60-3/4"

24 #69000 tote trays included with cabinet. Door lock is also included.



General Storage

69693 890mmL 550mmW 1550mmH
35" 21-5/8" 60-3/4"

Three full depth shelves; lock on door.

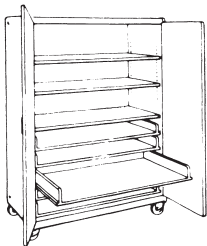

Flat Stock Storage

69713 890mmL 550mmW 1550mmH
35" 21-5/8" 60-3/4"

Two adjustable shelves; one fixed shelf; four heavy duty pullout shelves for flat stock up to 420mm x 813mm x 140mm (17"x32"x5-1/2"); lock on door.

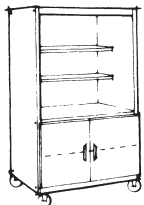

Counter and Storage

69723 890mmL 550mmW 1550mmH
35" 21-5/8" 60-3/4"

Upper section with two adjustable shelves, lower section cupboard with one adjustable shelf, lock on door.

Publication Display and File Storage

69733 890mmL 550mmW 1550mmH
35" 21-5/8" 60-3/4"

Upper section with two sloping shelves and lower section with four drawers; lock on drawers.

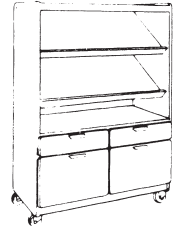

Display

69743 890mmL 550mmW 1550mmH
35" 21-5/8" 60-3/4"

Upper unit with locked glass sliding doors enclosing two adjustable shelves; cupboard with adjustable shelf and lock on door.

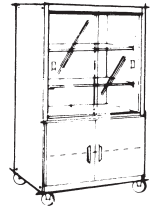

Tool/Work Bench

69763 890mmL 550mmW 1550mmH
35" 21-5/8" 60-3/4"

Upper section has perforated lining for tool display and storage; #86420 Utility Vise is attached to work top; one adjustable shelf; lock on door.

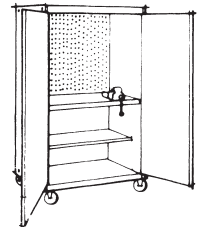

Adjustable Compartmental Storage

69783 890mmL 550mmW 1550mmH
35" 21-5/8" 60-3/4"

Three vertical spaces 267mm (10-1/2") wide and nine adjustable shelves; permits arrangement of compartments 267mm x 460mm (10-1/2"x18") front to back; lock on door.

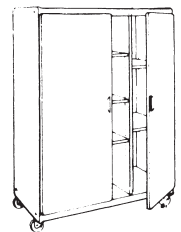

Material Transport

69793 1194mmL 550mmW 1550mmH
47" 21-5/8" 60-3/4"

Contains eight #69000 tote trays; eight #14220 carryalls, and twenty vertical dividers for boards and tray storage; lock on door.

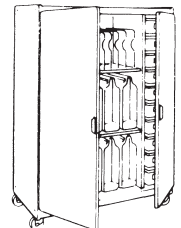

TRANSPORTS

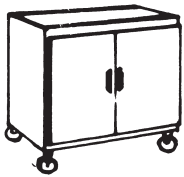

Cupboard Transport

39863 890mmL 550mmW 895mmH
35" 21-5/8" 35-1/4"

Integral hardwood top; four swivel casters; two with locking brakes; lock on door.

Flat Storage Transport

39911 890mmL 710mmW 895mmH
35" 28" 35-1/4"

Integral hardwood tops; four swivel casters, two with locking brakes. Six heavy duty pull out shelves for flat stock up to 610mm x 813mm x 140mm (24"x32"x 5-1/2").

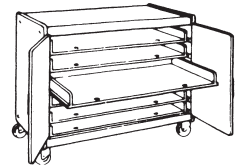

Cupboard Drawer Transport

39903 890mmL 550mmW 895mmH
35" 21-5/8" 35-1/4"

Integral hardwood top; four swivel casters; two with locking brakes; locks on drawers and doors.

Drawer Storage Transport

39909 890mmL 710mmW 895mmH
35" 28" 35-1/4"

Integral top; four swivel casters, two with locking brakes; seven drawers; each with lock.

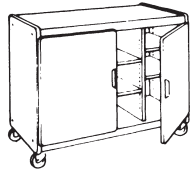
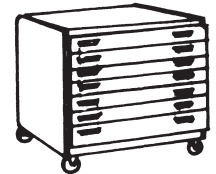

Compartmental Transport

39883 890mmL 550mmW 895mmH
35" 21-5/8" 35-1/4"

Integral hardwood top; four swivel casters; six adjustable shelves; nine compartments 267mm (10-1/2") wide; lock on door.

Supply Cart

39909 915mmL 610mmW 915mmH
36" 24" 36-1/2"

Shelved top and shelf. Reinforced bolted construction. Four swivel casters, two with locking brakes.

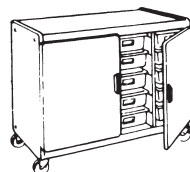

Tray Drawer Transport

39893 1194mmL 550mmW 895mmH
47" 21-5/8" 35-1/4"

Integral hardwood top; four swivel casters; two with locking brakes; lock on door; 12 #69000 tote trays. Tray runners to have automatic drawer stop and tray to be easily removable.

Supply Transport

72346 787mmL 431mmW 940mmH
31" 17" 37"

Two shelves with side rails to contain material, flat bottom shelf. Four swivel casters, two with locking brakes.

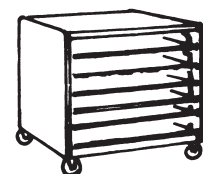

Flat Storage Transport

39913 890mmL 710mmW 895mmH
35" 28" 35-1/4"

Integral hardwood tops; four swivel casters, two with locking brakes. Six heavy duty pull out shelves for flat stock up to 610mm x 813mm x 140mm (24"x32"x 5-1/2").

Media Transport

72321 1168mmL 724mmW 990mmH
46" closed 28-1/2" 39"
1549mmL
61" open

Four swivel casters, two with locking brakes; two 110V outlets and 12 feet of power cord; one media cabinet 1016mm x 330mm x 686mm (40" x 13" x 27") with lock on door; one media cabinet 1016mm x 330mm x 686mm (40" x 13" x 27") with one adjustable shelf. Ideal for transporting variety of media and required projection equipment. Media cabinets can be removed from transport and inserted in EC Support System for work room usage.

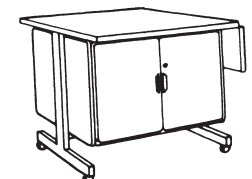

All Sheldon cabinets can be provided with locks, but they must be specified at time of ordering.

Base Cabinets (29" h. counter)

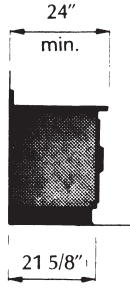

39100 24"W.
39110 18"W.



39500 24"W.
39510 18"W.



40400 24"W.
40410 18"W.



40900 18"W.



39000 47"W.
39010 35"W.



39400 47"W.
39410 35"W.

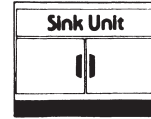

77310 47"W.
77320 35"W.

Base Cabinets (36" h. counter)

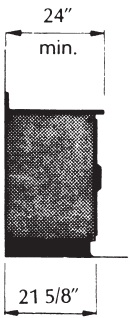

36050 24"W.
36060 18"W.



38250 24"W.
38260 18"W.



37050 24"W.
37060 18"W.

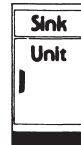

77350 24"W.
77360 18"W.



36000 47"W.
36010 35"W.

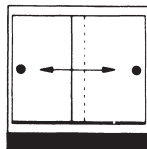

36030 47"W.
36040 35"W.

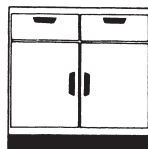

36200 47"W.
36210 35"W.



36500 47"W.
36510 35"W.



37000 47"W.
37010 35"W.



37100 47"W.
37110 35"W.



37250 47"W.
37260 35"W.

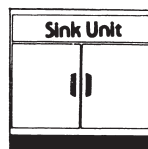

77260 47"W.
77270 35"W.

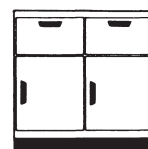

36407 35"W.



40110 35"W.



38256 35"W.

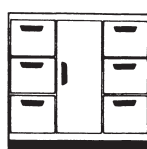

38571 35"W.

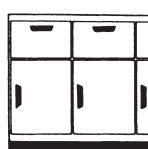

36405 47"W.

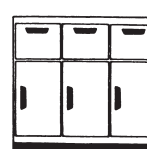

36406 47"W.

FLOOR CASES

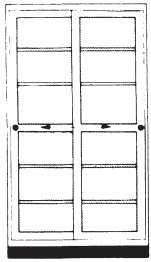

Display Case

61080

47" L
21-5/8" D
82-11/16" H

Furnished with sliding glass doors, four adj. shelves and one fixed center shelf.

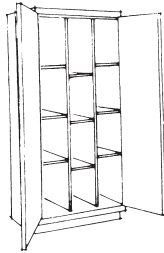

Compartmental Storage

61653

47" L
21-5/8" D
82-11/16" H

Three vertical spaces 310mm (12") wide and nine movable shelves. Permits arrangement of compartments 310mm x 460mm (12" x 18") front to back.



Illustrative Materials Case

62945

500mm L - 20"
550mm W - 21-5/8"
2100mm H - 82-3/4"

Open upper compartment is fitted with two sloped shelves for display. Lower section includes three file drawers 420mm x 430mm x 200mm (16-5/8" x 17" x 7-13/16" I.D.).

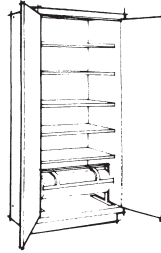

Roll Paper Storage

68351

47" L
21-5/8" D
82-11/16" H

Five shelves for cut stock up to 535mm x 970mm (21" x 38-1/2"). Paper holder for 910mm (36") roll paper. Fixed center shelf.

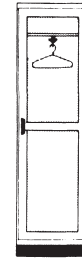

Wardrobe Case

65925

24" L
21-5/8" D
82-11/16" H

Provided with hat shelf and garment hanger with pull-out carrier.



Open Storage Case

68112

1000mm L - 39-3/8"
550mm W - 21-5/8"
2100mm H - 82-3/4"

Two adjustable shelves; one fixed center shelf.

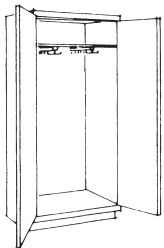

Smock-Apron Storage Case

68336

47" L
21-5/8" D
82-11/16" H

Two 24-hook pull-out carriers.

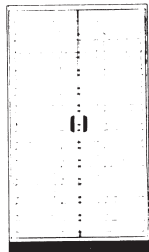

Tray Drawer Case

69210

47" L
21-5/8" D
82-11/16" H

Unit comes complete with 36 model no. 69000 tote trays.

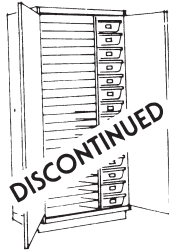

Project Materials Storage Case

69901

1000mm L - 39-3/8"
550mm W - 21-5/8"
2100mm H - 82-3/4"

12 tote trays #74272. 29 compartments for horizontal storage; compartments 60mm (2-3/8") high.



Cleaning Case

68328

24" L
21-5/8" D
82-11/16" H

Upper fixed shelf; six hooks for hanging brushes and other cleaning equipment; galvanized lined bottom and 152mm (6") high sides.

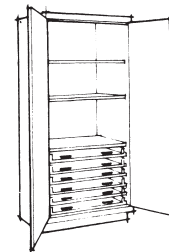

Flat Stock Storage

69666

47" L
21-5/8" D
82-11/16" H

Two adjustable shelves and one fixed shelf. Six pull out shelves for easy access and storage of flat materials. Stores materials up to 432mm x 916mm x 140mm (17" x 36-1/16" x 5-1/2").

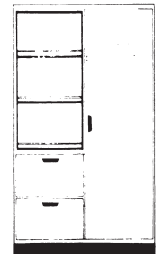

Instructor's Case

65928

47" L
21-5/8" D
82-11/16" H

Cabinet includes two file drawers, three sloping display shelves, and a wardrobe compartment with clothes rod and fixed hat shelf.

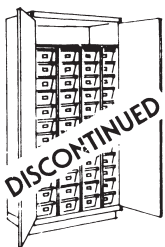

Tote Tray Case

68246

48 tote trays #74272 48mm x 19mm x 11mm (19" x 7-1/2" x 4-1/4"); hinged doors.

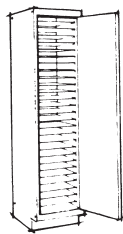

Hi-Density Horizontal Storage

68318

24" L
21-5/8" D
82-11/16" H

29 individual compartments each 470mm x 330mm x 60mm (18-1/2" x 13" x 2-3/8").

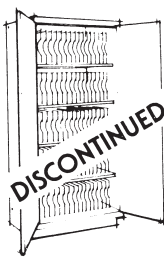

Hi-Density Vertical Storage

68240

1000mm L - 39-3/8"
550mm W - 21-5/8"
2100mm H - 82-3/4"

75 individual compartments each 60mm x 482mm x 360mm (2-3/8" x 19" x 14").

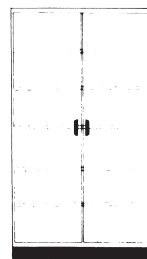

General Storage Case

69211

47" L
21-5/8" D
82-11/16" H

All purpose unit is furnished with full height solid doors. Four adjustable shelves and one fixed center shelf are standard.

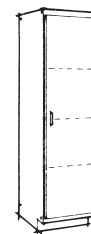

General Storage Case

68129

24" L
21-5/8" D
82-11/16" H

Two adjustable shelves and one fixed shelf.

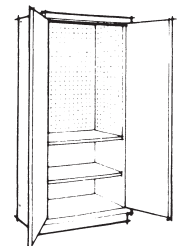

Tool Storage

68271

47" L
21-5/8" D
82-11/16" H

Upper area has on back and 2 sides perforated lining for tool display and storage; lower area has two adjustable shelves; hinged doors.

SHELVING

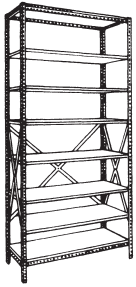

Metal Shelving

Initial

73730	914mmL 36"	305mmW 12"	2159mmH 85"
-------	---------------	---------------	----------------

Extension

73735	914mmL 36"	305mmW 12"	2159mmH 85"
-------	---------------	---------------	----------------

Initial

73740	914mmL 36"	457mmW 18"	2159mmH 85"
-------	---------------	---------------	----------------

Extension

73745	914mmL 36"	457mmW 18"	2159mmH 85"
-------	---------------	---------------	----------------

Open shelving type with sway braces for stability; fixed top and bottom shelves and six adjustable shelves on 38mm (1-1/2") centers. Expanded metal shelves provided as an option.

Utility Shelving

Full Height

73610	500mmL 20"	298mmW 11-3/4"	2100mmH 82-3/4"
73620	750mmL 30"	298mmW 11-3/4"	2100mmH 82-3/4"
73630	1000mmL 39-3/8"	298mmW 11-3/4"	2100mmH 82-3/4"
73640	500mmL 20"	550mmW 21-5/8"	2100mmH 82-3/4"
73650	750mmL 30"	550mmW 21-5/8"	2100mmH 82-3/4"
73660	1000mmL 39-3/8"	550mmW 21-5/8"	2100mmH 82-3/4"

Sheltex panel construction, fixed top and bottom shelves and five adjustable shelves on 13mm (1/2") centers. Finished back and expanded metal shelves provided as an option.

Intermediate Height

73670	500mmL 20"	298mmW 11-3/4"	1066mmH 42"
73680	750mmL 30"	298mmW 11-3/4"	1066mmH 42"
73690	1000mmL 39-3/8"	298mmW 11-3/4"	1066mmH 42"
73700	500mmL 20"	550mmW 21-5/8"	1066mmH 42"
73710	750mmL 30"	550mmW 21-5/8"	1066mmH 42"



EC SUPPORT SYSTEMS

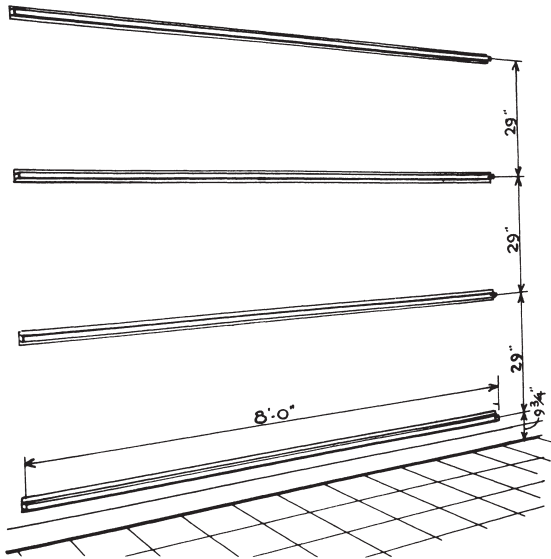

An environmental storage, display and learning system which is subject to educator change and control. All components of the system can be disengaged and rearranged within the system to suit changing activities or requirements.

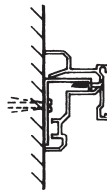

EC Wall Support Rail

7201-48	2438mmL 8'0"	41mmW 1-5/8"	70mmH 2-3/4"
---------	-----------------	-----------------	-----------------

Angle steel mounting rail and double "C" track aluminum support rail. End cap provides closure at exposed end of extrusion. Contact your Sheldon representative for details on attachment to wall.

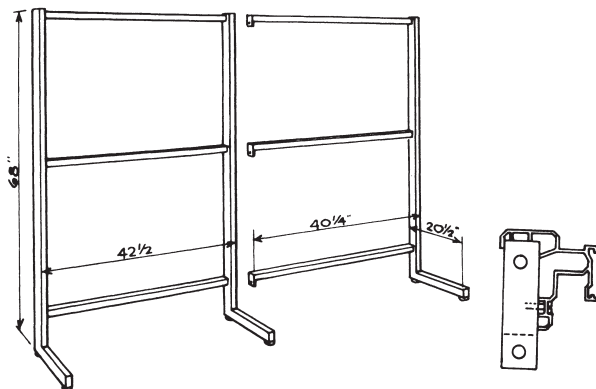

EC Relocatable Support (Single Side)

7203-34	1079mmL 42-1/2"	521mmW 20-1/2"	1727mmH 68"
---------	--------------------	-------------------	----------------

Initial

EC Initial Relocatable Support (Single Side)

7203-38	1022mmL 40-1/4"	521mmW 20-1/2"	1727mmH 68"
---------	--------------------	-------------------	----------------

Extension

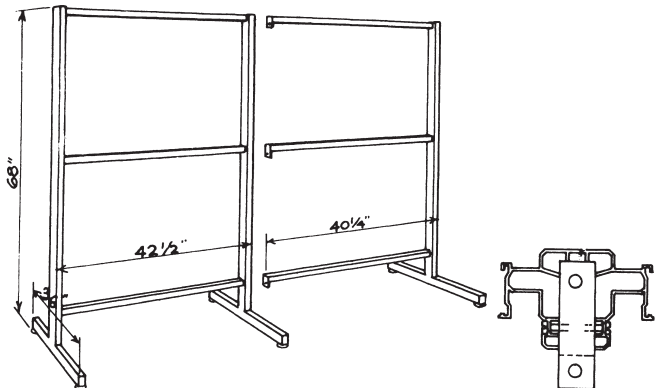

Two-level support for up to 1016mm (40") units; frame accepts sightbarrier; double "C" track accepts basic units, level 1, level 2, and double level units.

EC Initial Relocatable Support (Double Side)

7203-44	1079mmL 42-1/2"	914mmW 36"	1727mmH 68"
---------	--------------------	---------------	----------------

Initial

EC Relocatable Support (Double Side)

7203-48	1022mmL 40-1/4"	914mmW 36"	1727mmH 68"
---------	--------------------	---------------	----------------

Extension

EC BASIC UNITS

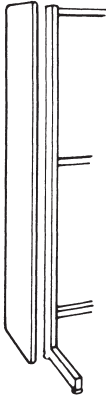

EC End Panel (Single Side)

7554-48511mmL 19mmW 1587mmH
22-1/2" 3/4" 62-1/2"

Vinylcork

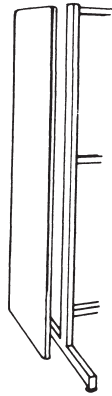

EC End Panel (Double Side)

7554-68787mmL 19mmW 1587mmH
31" 3/4" 62-1/2"

Vinylcork

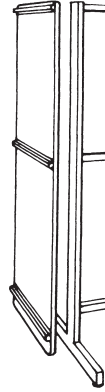

EC End Panel (Double Side)

7554-56787mmL 19mmW 1587mmH
31" 3/4" 62-1/2"

Plastic laminate; three EC Wall Support Rails, each 762mm (30") long and end caps.

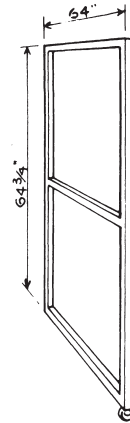

EC Panelwall

7205-251626mmL63mmW 1537mmH
64" 2-1/2" 60-1/2"

Two-level support to accept EC Sightbarriers. Panels can be attached together for display.



EC Light Cylinder

7267-10

Baffled R-40 spot light with cord; locks into outer "C" track.



EC Hook

7261-40

Locks into outer "C" track.

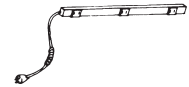

EC Power Adaptor

7266-13 762mmL 32mmW 25mmH
30" 1-1/4" 1"

762mm (30") long, three outlet with cord.



EC Rod Holder

7261-50

Locks into outer "C" track.



EC Bolt Holder

7261-60

Locks into outer "C" track.

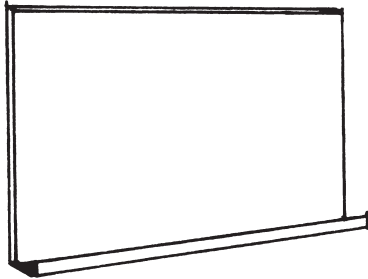

EC Framed Display Boards

Anodized aluminum frame; locks into inner "C" track.

Chalkboard

7183-14 40" 5/8" 28"

Magnet adhering porcelain, steel with full length chalktrough, white with decorative back of vinylcork.

7183-16 60" 5/8" 28"

Same as 7183-14.

Tackboard

7184-24 40" 5/8" 28"

Vinylcork on both sides.

7184-26 60" 5/8" 28"

Same as 7184-24.

Panel Post

7186-00

737mmH
29"

Extruded aluminum strip holds display panel; locks into outer "C" track, rotates 180°.

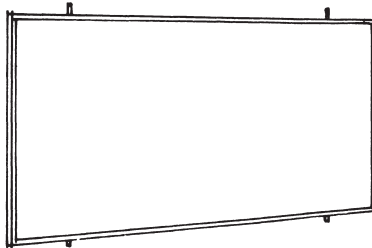

EC Sightbarrier

Anodized aluminum frame, inserts in frame of EC Relocatable Support.

7182-24 37-1/8" 5/8" 25-7/8"

Tackboard Vinylcork on both sides.

7182-34 37-1/8" 5/8" 25-7/8"

Chalkboard White magnet adhering porcelain on both sides.

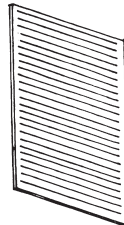

Display Panel

7185-11 483mmL 3mmW 711mmH
19" 1/8" 28"

25 white corrugated cardboards each with lines on one side in increments of 3mm, 19mm and 29mm (1/8", 3/4", and 1-1/8") on one side and blank on opposite.



Magnetic Chalktrough

7275-00

18" 3" 2-1/2"

For use on chalkboards without troughs.

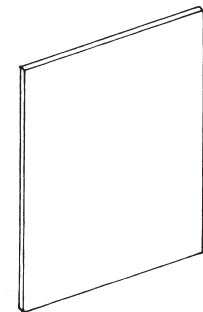

Mural Panel

7188-33 1041mmL 16mmW 1422mmH
41" 5/8" 56"

Clear unfinished novoply panels; ideal for securing large 2D work, material can be nailed, stapled or taped to panel.

LEVEL 1 UNITS



Drawer Cabinet

7110-36 1016mmL 508mmW 686mmH
40" 20" 27"

Three drawers 152mm (6") high and one drawer 203mm (8") high.



Drawer Cabinet

7110-33 508mmL 508mmW 686mmH
20" 20" 27"

Three drawers 152mm (6") high and one drawer 203mm (8") high.

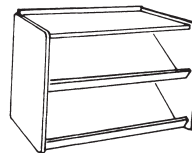

Display Cabinet

7180-16 1016mmL 483mmW 686mmH
40" 19" 27"

Two sloped shelves; shelves pivot to allow access to flat shelves at rear of pivoting shelf for storage of back issues.



Tote Tray Cabinet

7118-54 1016mmL 483mmW 686mmH
40" 19" 27"

15 #74240 tote trays 430mm x 290mm x 95mm (17" x 11-1/2" x 3-3/4").

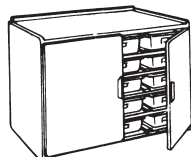

Tote Tray Cabinet

7118-64 1016mmL 508mmW 686mmH
40" 20" 27"

15 #74240 tote trays 430mm x 290mm x 95mm (17" x 11-1/2" x 3-3/4"); hinged doors.



Two Drawer File Cabinet

7110-83 508mmL 508mmW 686mmH
20" 20" 27"

Each drawer accommodates standard file folder crosswise and legal files lengthwise.

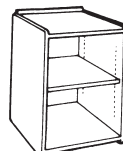

Open Storage

7113-13 508mmL 483mmW 686mmH
20" 19" 27"

One adjustable shelf.

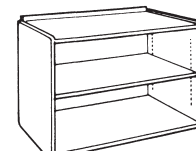

Open Storage

7113-16 1016mmL 483mmW 686mmH
40" 19" 27"

One adjustable shelf.

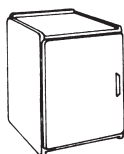

Cupboard Cabinet

7112-13 508mmL 508mmW 686mmH
20" 20" 27"

One adjustable shelf.

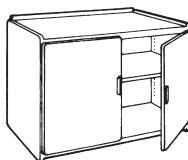

Cupboard Cabinet

7112-56 1016mmL 508mmW 686mmH
40" 20" 27"

One adjustable shelf.

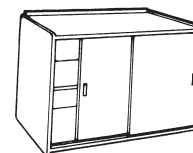

Sliding Door Cupboard

7112-86 1016mmL 508mmW 686mmH
40" 20" 27"

One adjustable shelf.

LEVEL 2 UNITS

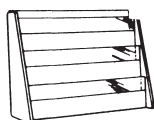

Magazine Display

7179-16 1016mmL 279mmW 721mmH
40" 11" 28-3/8"

Sheltex panel construction; steel shelves and clear plexiglass front retention panels; three display levels 229mm x 51mm (9" x 2"). May be used on any support means or may stand free on floor.



Sloped Storage

7107-02 508mmL 187mmW 686mmH
20" 7-3/8" 27"

Three sloped shelves.

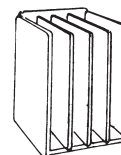

Display Panel Storage

7115-02 508mmL 508mmW 686mmH
20" 20" 27"

Storage for 48 Display Panels or can be used for prints, posters, etc.



Scissor and Ruler Storage

7158-02 508mmL 76mmW 711mmH
20" 3" 28"

Storage for thirty scissors and thirty rulers. Scissors and rulers not included.

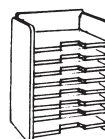

Horizontal Divider Storage

7104-11 508mmL 305mmW 686mmH
20" 12" 27"

Open top shelf; ten horizontal dividers at 51mm (2") increments.

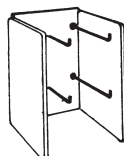

Bag Storage

7108-22 508mmL 305mmW 771mmH
20" 12" 28"

Four hooks; eight clear vinyl bags 324mm x 229mm (12-3/4" x 9").

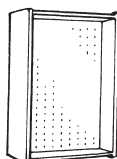

Tool Storage

7158-03 508mmL 187mmW 686mmH
20" 7-3/8" 27"

Back has perforated lining for tool display and storage.

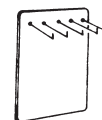

Apron/Smock Storage

7108-42 508mmL 229mmW 711mmH
20" 9" 28"

Five hooks.



Small Parts Storage

7157-02 508mmL 127mmW 711mmH
20" 5" 28"

Metal frames to accept twenty-four clear plastic jars with caps.

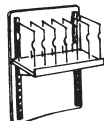

Multi-Function Storage

7158-04 508mmL 254mmW 711mmH
20" 10" 28"

One adjustable shelf with front retaining rail; six wire dividers 203mm x 210mm (8" x 8-1/4"); shelf brackets adjust from flat to 15° or 30° or 45°. Shelves pre-drilled on 25mm (1") centers to accept wire dividers.

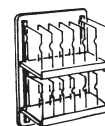

Multi-Function Storage

7158-05 508mmL 254mmW 711mmH
20" 10" 28"

Same as #7158-04 except with two shelves.

DOUBLE-LEVEL UNITS

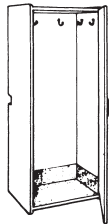

Cleaning Cabinet

7130-70 508mmL 508mmW 1422mmH
20" 20" 56"

Galvanized lined bottom and 157mm (6") high sides, six hooks.



Open Storage

7126-16 1016mmL 482mmW 1422mmH
40" 19" 56"

Three adjustable shelves.

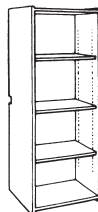

Open Storage

7126-13 508mmL 483mmW 1422mmH
20" 19" 56"

Three adjustable shelves.



General Storage

7126-33 508mmL 508mmW 1422mmH
20" 20" 56"

Three adjustable shelves, hinged door.

7126-66 1016mmL 508mmW 1422mmH
40" 20" 56"

Three adjustable shelves, hinged doors.

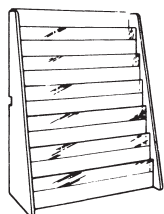
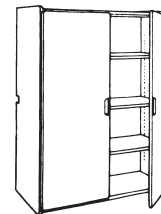

Magazine Display

7179-26 1016mmL
40" 18-7/8" 58-7/8"

Sheltext panel construction; steel shelves and clear plexiglass front retention panels; six display levels 229mm x 51mm (9" x 2"). May be used on support means or may stand free on floor.

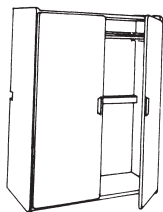

Wardrobe Storage

7130-66 1016mmL 508mmW 1422mmH
40" 20" 56"

Fixed shelf; full length rod; hinged door.

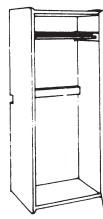

Wardrobe Storage

7130-33 508mmL 508mmW 1422mmH
20" 20" 56"

Fixed shelf; full length rod; hinged door.

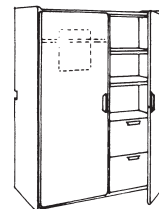

Instructor's Case

7113-46 1016mmL 508mmW 1422mmH
40" 20" 56"

Left section with fixed shelf; full length rod; mirror, hinged door; right section with two file drawers; each drawer accommodates standard file folders crosswise and legal files lengthwise; two adjustable shelves, hinged door; locks on doors.

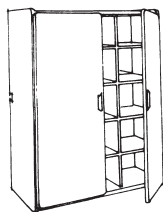

Cubicle Case

7113-55 1016mmL 508mmW 1422mmH
40" 20" 56"

15 cubicles; nine to be 254mm x 305mm x 279mm (10" x 12" x 11") and six to be 279mm x 305mm x 279mm (11" x 12" x 11"); hinged doors.

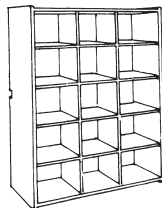

Cubicle Case

7113-46 1016mmL 305mmW 1422mmH
40" 12" 56"

Same as #7113-55, except without doors.

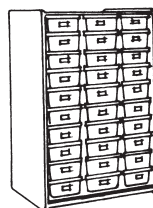

Tote Tray Case

7118-80 1016mmL 483mmW 1422mmH
40" 19" 56"

30 #74240 tote trays 430mm x 290mm x 95mm (17" x 11-1/2" x 3-3/4").

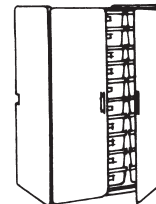

Tote Tray Case

7118-90 1016mmL 508mmW 1422mmH
40" 20" 56"

Same as #7118-80 except with hinged doors.

COUNTER

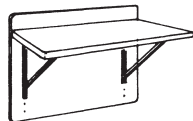

Adjustable Counter

7187-15 1016mmL 508mmW 711mmH
40" 20" 28"

Plastic laminate counter, adjustable in increments of 51mm (2").

7187-17 1524mmL 508mmW 711mmH
60" 20" 28"

Same as #7187-15.



Plug-In Counter

7187-34 1016mmL 508mmW 25mmH
40" 20" 1"

Plastic laminate counter; locks into outer "C" track.

7187-36 1524mmL 508mmW 25mmH
60" 20" 1"

Same as #7187-34.

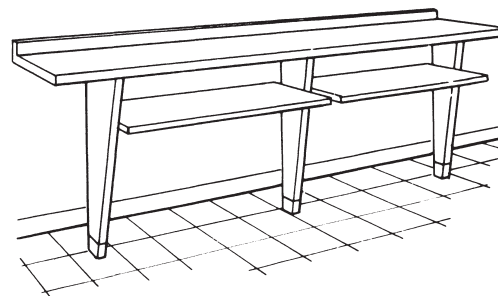

Wall Counter

57561 1016mmL 457mmW 914mmH
40" 18" 36" to counter

Plastic laminate counter with 51mm (2") high rear curb; shelf is 305mm (12") wide; solid hardwood uprights.



Wall Shelving

73180 1000mmL 305mmW 305mmH
39-3/8" 12" 12"

73190 1000mmL 457mmW 305mmH
39-3/8" 18" 12"

Plastic laminate counter with 51mm (2") high rear curb.

ACCESSORIES FOR ART STUDIOS FACILITIES

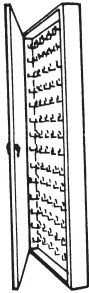

Key Case

24930 464mmL 57mmW 870mmH
18-1/4" 2-1/4" 34-1/4"

96 hooks, each holding one to three keys and each with label holder; finished in dove gray enamel; lock on door.



Tray Drawers

74240 430mmL 290mmW 95mmH
17" 11-1/2" 3-3/4"

Glass reinforced fiberglass; rim returned for extra strength; label holder.



Tote Tray

74272 483mmL 190mmW 108mmH
19" 7-1/2" 4-1/4"

Polyester; rim returned for extra strength; label holder.



85101

85401



85101

Electrical box, plate, two 3-wire grounded, 115A; 125-250 volt receptacles; for mounting in rail.

85401
Electrical pedestal box, plates, four 3-wire grounded; 115A, 125-250 volt receptacles; for deck mounting.

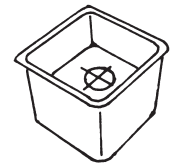

Tub Sink

78790 610mmL 533mmW 330mmH
24" 21" 13"

Fiberglass reinforced plastic tub.

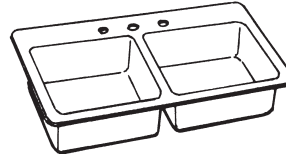

Stainless Steel Sink

78680 737mmL 457mmW 184mmH
29" 18" 7-1/4"

78690 838mmL 495mmW 184mmH
33" 19-1/2" 7-1/4"

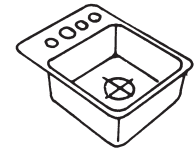

Stainless Steel Sink

78660 483mmL 457mmW 184mmH
19" 18" 7-1/4"

78670 559mmL 495mmW 184mmH
22" 19-1/2" 7-1/4"

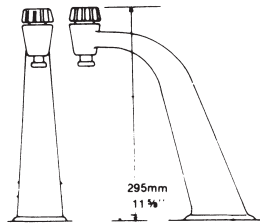
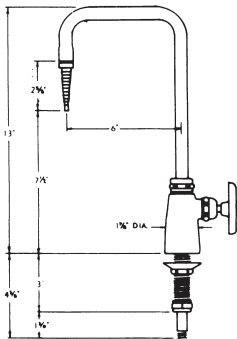

Unicast

80022

Cold water service fixture. Specially designed to withstand student abuse.

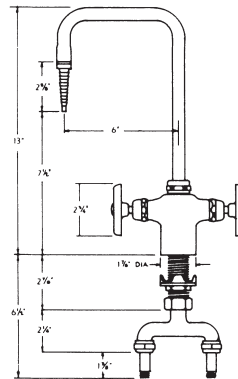

80100

Hot and cold water gooseneck fitting; for deck mounting.

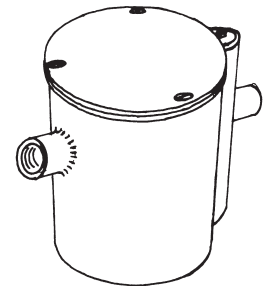

Plaster Trap

82275

Cast iron interceptor with removable perforated nickel screen basket, 216mm (8-1/2" diameter x 317mm (12-1/2").

80000

Single hot or cold water gooseneck fitting; for deck mounting.

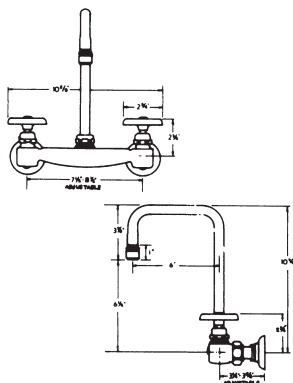

80300

Hot and cold water gooseneck fitting; for panel mounting.

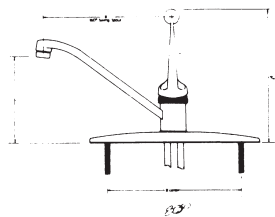

80350

Swing spout hot and cold water fittings; single handle control; aerator; for deck mounting.



Aerator

81020

Threaded to fit all gooseneck fittings shown.



86240

Lock for frameless plate glass doors; this lock cannot be keyed with #86230.



86230

Door and drawer lock; may be individually keyed, keyed alike and master keyed.



86180

Solid brass padlock hasp.

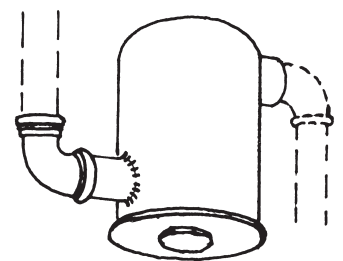

Plaster Trap

82270

Cast brass interceptor with removable perforated brass screen basket, 117mm (4-5/8" diameter x 165mm (6-1/2").

ACCESSORIES CONTINUED

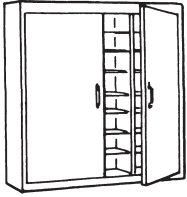

Safety Glasses Case

31170 760mmL 205mmW 914mmH
30" 8" 36"

Steel cabinet; capacity for thirty-six pairs of safety glasses and eight pairs of goggles; automatic timer control, germicidal lamp; lock on door. Glasses and goggles not included.

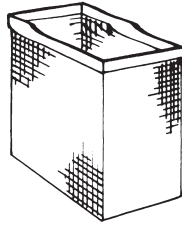

Removable Bin

86555

Mesh bin; frame metal top; for attachment to inside of cabinet door.

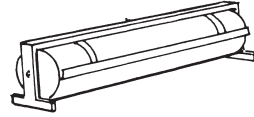

Roll Paper Dispenser

86860

Holder with tear off bar; accommodates roll paper up to 914mm (36") wide.

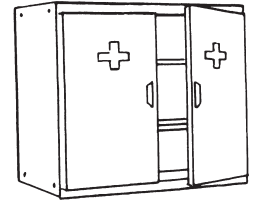

First Aid Case

66108 1000mmL 400mmW 700mmH
39-3/8" 15-3/4" 30-1/2"

Doors of white plastic laminate with red cross symbols applied; two adjustable shelves.

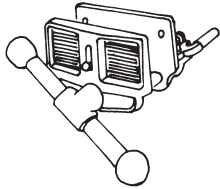

Woodworker's Vise

86435

Medium duty clamp, jaws 76mm x 165mm (3" x 6-1/2"); opening to 178mm (7"); for deck mounting.

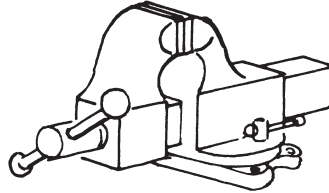

Machinist's Vise

86420

Heavy duty clamp, jaws 89mm (3-1/2"), opening to 127mm (5"); swivels full 360°; for deck mounting.

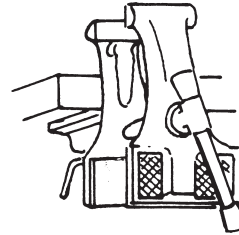

Combination Vise

86400

Equipped with woodworking and metal working jaws; either set of jaws may be swung into working position by loosening the locking level and rotating vise a half turn.

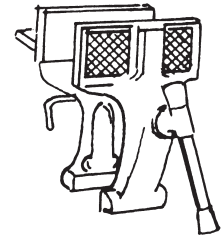
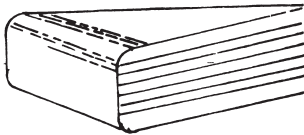

TABLE TOP AND COUNTER MATERIALS

Art Studio tops may be specified of the following materials and thicknesses. Use the code symbol

plus the catalog number to identify the top desired with the item.



Shelweld Tops

Wood fiber compressed into hard surfaced sheets, finished in clear durable finish. Code -- SC -- 32mm (1-1/4") thick.

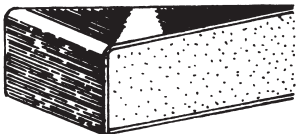

Plastic Laminate Tops

Composition core; counter edges are banded with same plastic laminate material as the top surface. Table tops are banded with "T" molding. Code -- PL -- 32mm (1-1/4") thick.

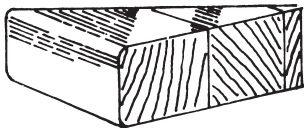

Hardwood Maple Tops

Code -- H -- 32mm (1-1/4") thick.
Code -- HH -- 57mm (2-1/4") thick.

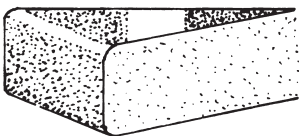

Sheldine Tops

The ultimates for heat resistance. They will stain, but structurally they remain good working surfaces. Code -- S -- 32mm (1-1/4") thick.

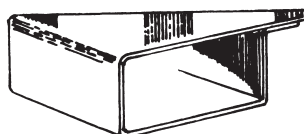

Stainless Steel Tops

16USS gauge (.0625) of type 302, 18-8 with No. 4 satin finish; dark room sink type 316, 18-8 with No. 4 satin finish. Code -- CRM -- 32mm (1-1/4") thick.

INDEX

A Accessories	31, 32	O Open Frame Table	8
Acid Bottle Carrier	21	Overhead Mirror	6
Adjustable Top Art Center	9	P Padlock Hasp	31
Aerator	31	Painting	8, 9, 11, 13, 14, 15
All Purpose Table	8	Panel Post	28
Art Bench	9	Panel Print Holder	13
Art Horse	9	Panel Wall	12, 28
Art Stool	9	Paper Storage	11, 23
Apron Storage	26, 29	Photography	19, 20
Audio-Visual Equip. Storage	7, 23, 24, 26	Photography Developing Centers	19
B Bag Storage	29	Plain Rod	13
Base Cabinets	25, 29	Plaster Traps	31
Benches	10	Plastic Laminate Top Materials	32
Bench Top Materials	32	Plumbing Fixtures	31
Bi-Level Project Center	9	Portable Drying Rack	11
Bolt Holder	15, 28	Posterboard Storage	11, 23
Burn-Out Booth	22	Power Adapter	15, 28
C Canopy Hood	22	Print Drying Racks	20
Carryall Storage	8, 9, 23	Project Benches	10
Carts	24	Project Centers	9, 14, 15
Centrifugal Casting Well	21	Project Materials Storage	11, 23, 24, 25, 26
Ceramics	16, 17, 27	Project Storage	16, 17, 20, 21
Chalkboards	7, 28	Projector Equipment Storage	7, 23, 24
Chalkscreen Projection Center	7	Projector Stand	7
Clay Material Storage	17	Publication Display	23, 26, 29
Cleaning Case	26	Q Quench Tank	18, 22
Counter Top Material	29, 32	R Relocatable Support	27
Craft Paper Dispenser	10, 26, 32	Removable Bin	32
Craft Project Bench	10	Rod Holder	28
D Damp Cabinet	17	Roll Paper Dispenser	10, 26, 32
Display	12, 13, 14, 15, 23, 26, 28, 29	Ruler Storage	29
Display Panels	28	S Safety Case	32
Display Panel Storage	29	Safety Glasses Storage	32
Drawer Trays	9, 10, 23, 24, 25, 26, 31	Scissors Storage	29
Drawing	8, 9, 11, 13, 14, 15	Sculpture	17, 21, 22
Drawing Board Storage	11	Sculpture Stations	16, 22
Drying Racks	17, 20, 27	Seating	9
Dual Rod Holder	13	Sheldine Tops	32
E EC Basic Units	28	Shelving Tops	27, 30
EC End Panels	28	Shelwell Tops	32
EC Panelwall	28	Side Arm Holder	13
EC Support Systems	28	Sink Cabinet	25
Electrical Receptacles	15, 28, 31	Sinks	18, 19, 25, 31
Enlarger Booth	20	Sink Service Turret	18
F File Cabinets	23, 25, 29	Sink Service Wall	18
First Aid Case	32	Sliding Chalkboard	7
Fittings	31	Small Parts Storage	29
Fixtures	31	Smock Storage	26, 29
Flat Stock Storage	23, 24, 26	Spacer Rod	13
Floor Cases	26	Spray Booth	17
G Glasses Storage Case	32	Stainless Steel Tops	32
Glazing Booth	17	Stool	9
Glazing Material Storage	17	Storage	11, 17, 23, 24, 25, 27, 29
Goggle Storage Case	32	Student Work Towers	14, 15
H Hanger Rod	13	T Tables	8
Hardwood Tops	32	Table Top Materials	32
Hasps	31	Tackboards	7, 12, 28
Heavy Duty Benches	10	Tall Cases	26
Hoods	22	Teachers Case	26
Hooks	15, 28	Teachers Desk	6
Horizontal Storage	10, 11, 26, 29	Tool Storage	23, 26, 29
I Instructional Centers	6, 7	Tote Trays	9, 23, 24, 25, 26, 29, 31
Instructor's Case	26	Tower	14, 15
Instructors Conference Center	6	Tower Bolt Hook	15
Instructors Demonstration Center	7	Tower Lights	15
Island Sink	18	Tower Modular Boards	15
J Jewelry	17, 21, 22	Tower Support Rail	15
Jewelry Station	21	Transports	24
K Key Case	31	Traps	31
L Legs	9	Twin Clips	13
Level Hang Hook	13	U Unicast Fixture	31
Long Holder	13	V Vertical Storage	11, 26
Level 1 Units	29	Vises	32
Level 2 Units	29	Visual Aider Mirror	6
Light Table	20	W Wall Counter	30
Lights	15, 28	Wall Shelving	30
Locks	31	Wall Sinks	18
M Magazine Display	23, 26, 29	Wall Supports	27
Magnetic Chalk Trough	28	Wardrobe Storage	26
Media Transport	24	Waste Receptacles	32
Mobile Chalkboard/Tackboard	7	Water Fittings	31
Mobile Storage	23, 24	Wedging Station	16
Modeling Stand	7, 8, 14, 15	Wet Photo Developing Center	19
Mural Display	13, 28	Work Bench	10, 23
Mural Panel	28	Work-in-Process Storage	11, 17, 23, 24, 26
N			

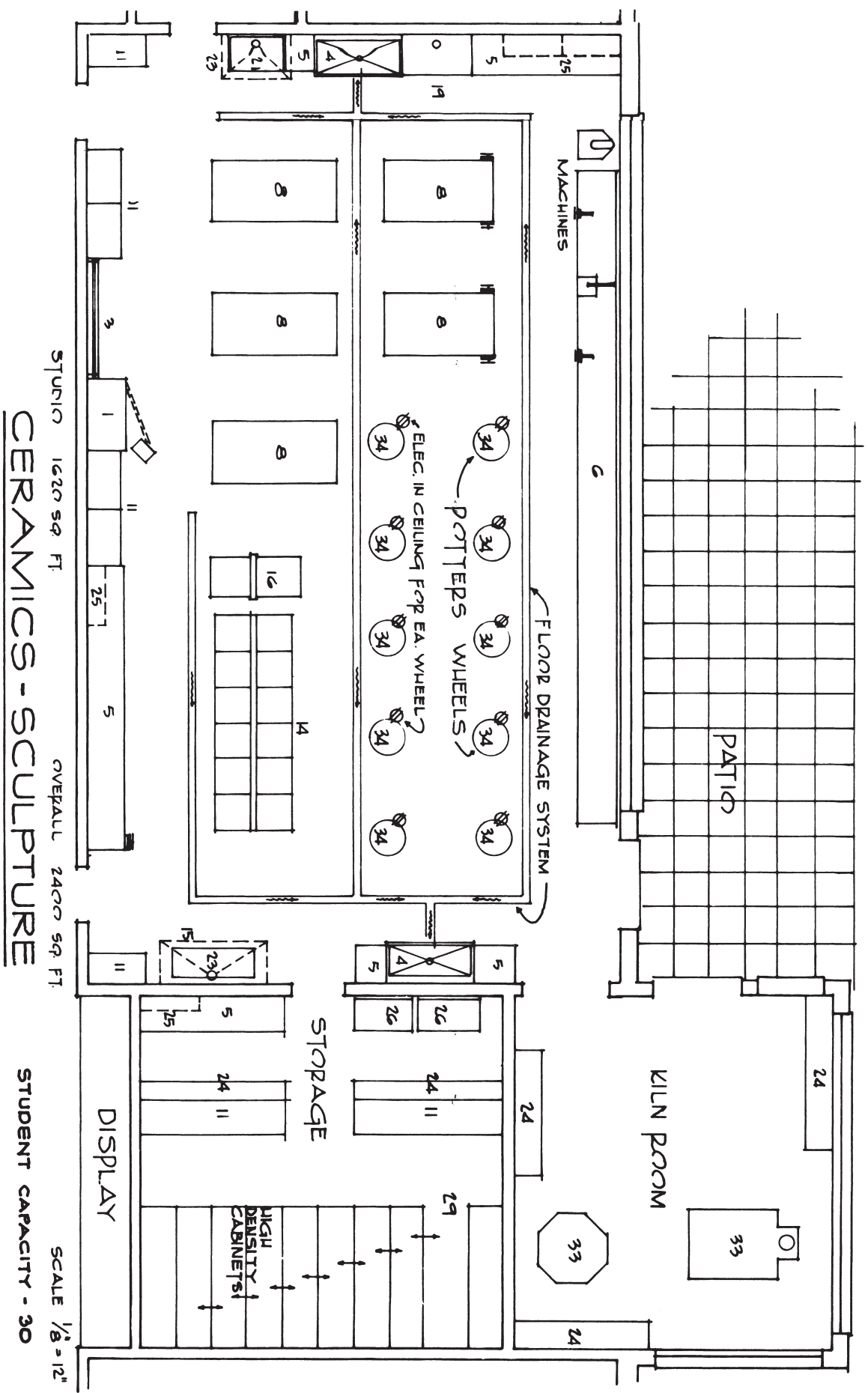

No.	Name of Item	Book Pages
1	Chalkscreen Projection Center	7
2	Overhead Mirror	6
3	Chalkboards	7, 26
4	Studio Sinks	16
5	Counter	23, 29
6	Workbench	10, 25
7	Student Tables	8, 9
8	Project Stations	10, 14, 15, 16, 21
9	Drawing Stations	8, 9
10	Instructors Stations	6, 7
11	Double-Level Storage Cases	26, 30
12	Enlarger Booth	20
13	Photographic Sinks	19
14	Wedging/Sculpture Stations	16
15	Pug Mill	•
16	Clay Roller	•
17	Print Press	•
18	Dorm Cabinet	•
19	Glazing Booth	17
20	Jewelry Station	21
21	Welding Station	22
22	Centrifugal Casting Well	21
23	Canopy Hoods	22
24	Shelving/Drying Racks	27
25	Level 2 Storage	29
26	Mobile Storage/Transports	23, 24
27	Light Table	20
28	Portable Chalkboard	7
29	Hi-Density Shelving	•
30	Print Drying	20
31	Burn Out Booth	22
32	Looms	•
33	Kilns	•
34	Potters Wheels	•
35	Display	12, 13, 28

*These items are not included in the book.

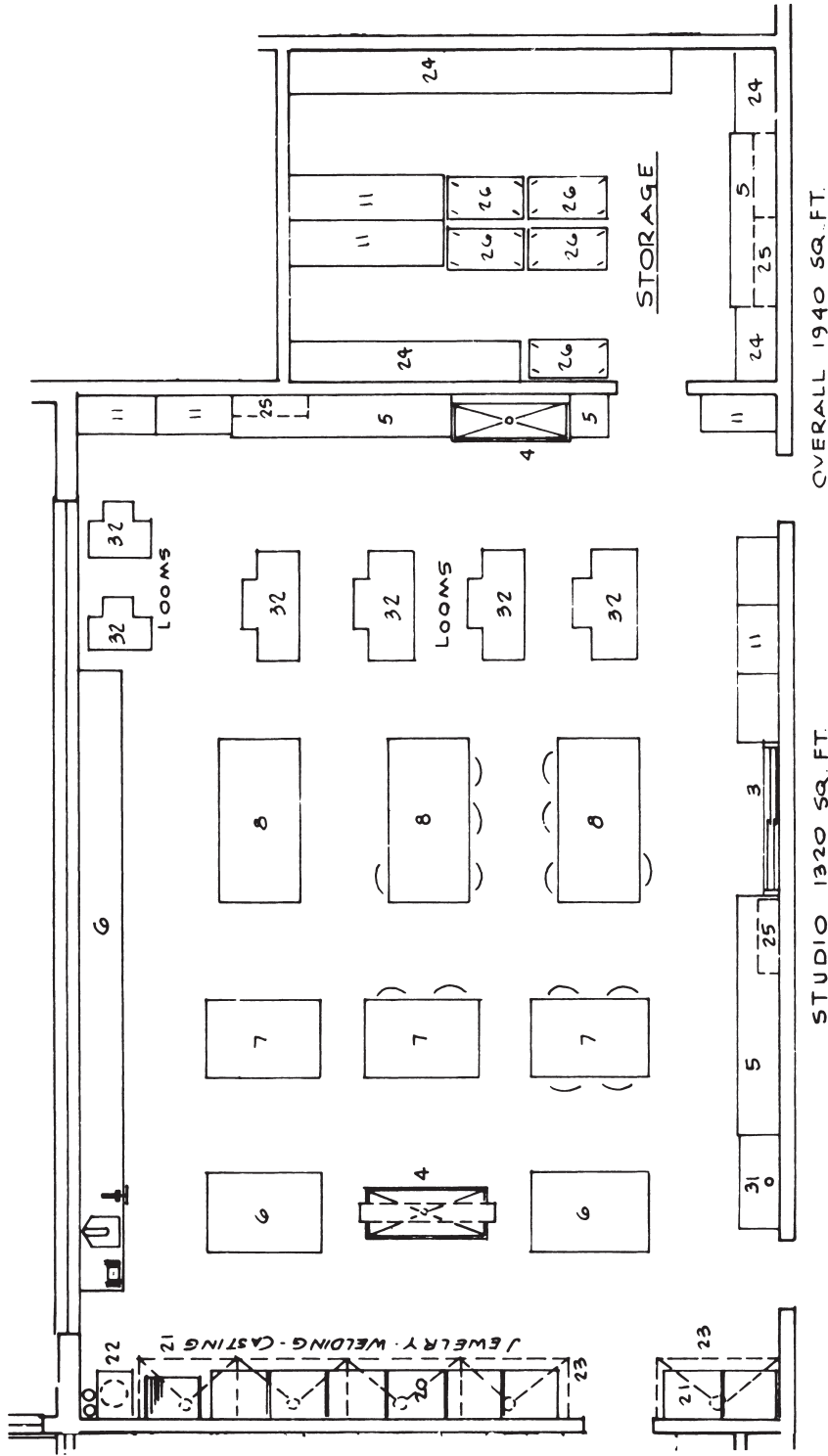

JEWELRY - TEXTILES

STUDENT CAPACITY - 24

No.	Name of Item	Book Pages
1	Chalkscreen Projection Center	7
2	Overhead Mirror	6
3	Chalkboards	7, 28
4	Studio Sinks	18
5	Counter	25, 29
6	Workbench	10, 25
7	Student Tables	8, 9
8	Project Stations	10, 14, 15, 16, 21
9	Drawing Stations	8, 9
10	Instructors Stations	6, 7
11	Double-Level Storage Cases	26, 30
12	Enlarger Booth	20
13	Photographic Sinks	19
14	Wedging/Sculpture Stations	16
15	Pug-Mill	*
16	Clay Roller	*
17	Print Press	*
18	Damp Cabinet	17
19	Glazing Booth	17
20	Jewelry Station	21
21	Welding Station	22
22	Centrifugal Casting Well	21
23	Canopy Hoods	22
24	Shelving/Drying Racks	27
25	Level 2 Storage	29
26	Mobile Storage/Transports	23, 24
27	Light Table	20
28	Portable Chalkboard	7
29	Hi-Density Shelving	*
30	Print Drying	20
31	Burn Out Booth	22
32	Looms	*
33	Kilns	*
34	Potters Wheels	*
35	Display	12, 13, 28

*These items are not illustrated in the book.

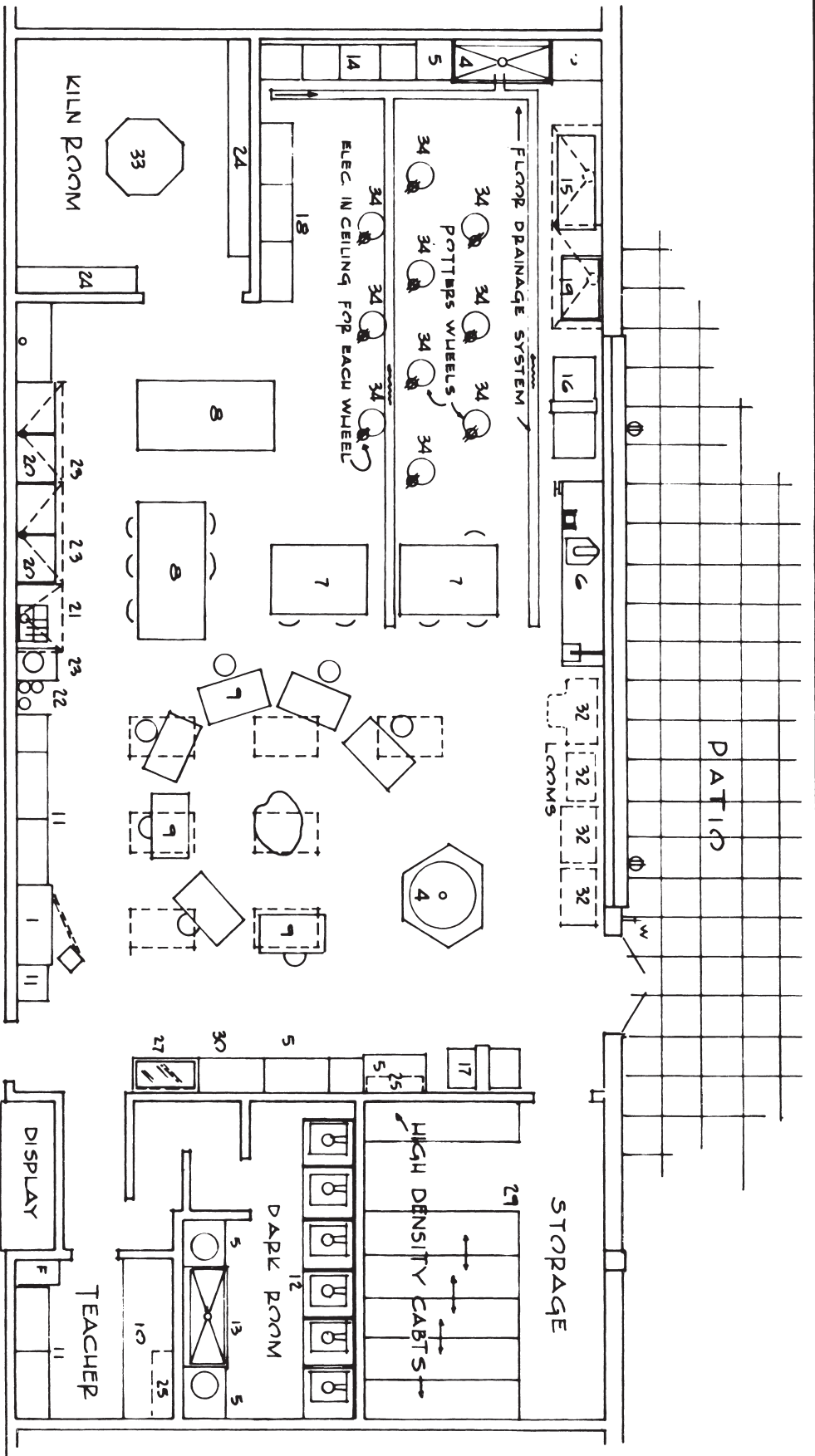

STUDIO 1728 SQ. FT.

2100 SQ. FT. OVERALL

SCALE 1/8" = 12"

DRAWING - PAINTING
PRINTMAKING
TEXTILES

JEWELRY
CERAMICS
PHOTOGRAPHY

ALL PURPOSE
ART STUDIO
STUDENT CAPACITY - 32

No.	Name of Item	Book Pages
1	Chalkgreen Projection Center	7
2	Overhead Mirror	6
3	Chalkboards	7, 28
4	Studio Sinks	18
5	Counter	25, 29
6	Workbench	10, 25
7	Student Tables	8, 9
8	Project Stations	10, 14, 15, 16, 21
9	Drawing Stations	8, 9
10	Instructors Stations	6, 7
11	Double-Level Storage Cases	26, 30
12	Enlarge Booth	20

13	Photographic Sinks	19
14	Wedging/Sculpture Stations	16
15	Pug Mill	16
16	Clay Roller	.
17	Print Press	.
18	Domp Cabinet	17
19	Glazing Booth	17
20	Jewelry Station	21
21	Welding Station	22
22	Centrifugal Casting Well	21
23	Canopy Hoods	22
24	Shelving/Drying Racks	27

25	Level 2 Storage	29
26	Mobile Storage/Tranports	23, 24
27	Light Table	20
28	Portable Chalkboard	7
29	Hi-Density Shelving	20
30	Print Drying	20
31	Burn Out Booth	22
32	Looms	.
33	Kilns	.
34	Potters Wheels	.
35	Display	12, 13, 28

*Items from the book included in the book

NOTICE

Sheldweld material has been discontinued. Except for the items listed below, all items in the catalog noted to be furnished with Shelweld material will be furnished with 1-1/4" plastic laminate material in Sheldon's twilight color.

The following items, as stated above, will be furnished with 1-1/4" Resistop:

Item Nos.: 18933
27475
53560
53570



Innovative · Reliable · On Time · Complete



102 Kirk Street
Post Office Box 836
Crystal Springs, MS 39059
1.800.531.7604 phone
601.892.4364 fax
sales@sheldonlabs.com
www.sheldonlabs.com